



User manual

GEMAC Motus® BLACKLINE Xx digital

Version: 1.0

Date: 14.06.2023



XB6MP360-C
XB6MP360-J
XB2MP360-O
XC6MP360-C
XC6MP360-J
XC6MP360-O

GEMAC Chemnitz GmbH
Zwickauer Straße 227
09116 Chemnitz
Germany

Phone: +49 371 3377-0
Fax: +49 371 3377-272
Email: info@gemac-chemnitz.de
Web: www.gemac-chemnitz.com

Revision History

Date	Revision	Change(s)
14.06.2023	1.0	first version

© Copyright 2023 GEMAC Chemnitz GmbH

This document is subject to change without notice.

We constantly work to further develop of our products. We reserve any changes of the scope of delivery in shape, equipment and technology for ourselves. No claims can be made from the details, illustrations and descriptions in this document. Any kind of duplication, reprocessing and translation of this document as well as excerpts from it require the written permission of GEMAC Chemnitz GmbH. All rights according to the copyright remain explicitly reserved for GEMAC Chemnitz GmbH.

Note:

To use the sensor and for proper understanding of this manual, general knowledge of the field bus system CAN-Bus, CANopen respectively SAE J1939 is required.

Table of contents

1	Safety information	1
1.1	Incoming inspection	1
1.2	Intended use	1
1.3	Incorrect use	1
1.4	Requirements for the qualification of personnel	1
2	Overview.....	2
2.1	Characteristics	2
2.2	Applications.....	2
3	Technical Data.....	3
4	Mounting position / orientation of the measuring axes.....	5
4.1	Swap the measuring axes.....	6
5	Mounting.....	7
5.1	Fixation.....	7
5.2	Position of mounting holes	7
6	Connection	8
6.1	General connection information	8
6.2	Requirements to the voltage supply.....	8
6.3	Connector Pin Out.....	8
6.4	Internal circuit.....	9
6.5	Bus-Termination Resistor	9
7	Functional description.....	10
7.1	Low pass filter	10
7.2	Sensor fusion filter	11
7.2.1	Functionality.....	11
7.2.2	Advanced configuration of the sensor fusion filter.....	11
7.2.3	Drift compensation of the rotation rate	12
8	Functional description of the CAN interface.....	13
8.1	Orientation of the measuring axes	13
8.2	Zero Point Adjustment.....	13
8.3	Digital filter	13
8.4	Sensor fusion algorithm	13
8.5	Status LED	14
8.6	Format of the CAN Frames	14
8.6.1	Data Part in the CAN Frame.....	14

8.6.2	Status Byte (STATUS)	15
8.7	Boot Up Message.....	15
8.8	Read/Write device parameters.....	16
8.8.1	Set Parameter Frame	16
8.8.2	Reply Parameter Frames	17
8.9	Default Device Parameters	18
8.10	Transfer of the inclination values (perpendicular angle)	19
8.10.1	Polling Mode	19
8.10.2	Synchronous Mode.....	19
8.10.3	Cyclic Mode	20
8.11	Transfer of alternative output values.....	20
8.11.1	Euler-Angles	20
8.11.2	Angular Rate output (Gyro sensor raw data).....	21
8.11.3	Transfer of acceleration values.....	21
8.11.4	Output of relative angles (gyro angles).....	21
8.12	Configuration of the sensor	22
8.12.1	Configuration of Cyclic Mode.....	22
8.12.2	Configuration of the CAN Identifier	22
8.12.3	Configuration of the Baud Rate	22
8.12.4	Configure Automatic Bus-Off Recovery.....	23
8.12.5	Configure measuring axes and orientation.....	23
8.12.6	Configuration Cut-off frequency of the low pass filter.....	23
8.12.7	Configuration of Sensor Fusion	23
8.12.8	Configuration of Zero Point Adjustment.....	24
8.12.9	Restoration of Default Device Parameters	24
8.12.10	Save Device Parameters	25
8.12.11	Perform a software reset	25
9	Functional Description CANopen interface.....	26
9.1	Overview of Function	26
9.2	CANopen Structure	27
9.3	CANopen Device Model.....	27
9.4	COB-IDs	28
9.5	Network Management: NMT	28
9.6	Process Data: PDO (TPDO1 – TPDO4)	29
9.6.1	PDO Communication Types	30
9.6.1.1	Individual Request (Polling)	30
9.6.1.2	Cyclic Transmission.....	30
9.6.1.3	Synchronous Transmission	30
9.6.1.4	Event-controlled transmission on inclination change (manufacturer specific)	31

9.7	Service Data: SDO	31
9.8	Object Dictionary	32
9.8.1	Communication Parameters (according to CiA DS-301).....	32
9.8.1.1	Error Register (1001h).....	35
9.8.1.2	Manufacturer Status Register (1002h).....	35
9.8.1.3	Pre-defined Error Field (1003h)	35
9.8.1.4	Saving (1010h) and Loading (1011h) of Parameters	36
9.8.1.5	Transmit PDO – Transmission Type (1800h / 1801h / 1802h / 1803h).....	36
9.8.2	Manufacturer Specific Part	36
9.8.2.1	Automatic Bus-Off Recovery (2002h)	38
9.8.2.2	Low Pass Filter Settings (3000h)	38
9.8.2.3	TPDO1 Transmission on Inclination Change (3001h).....	38
9.8.2.4	Configuration of the sensor fusion (3002h).....	39
9.8.2.5	Configuration of the mounting position / measuring axes (3003h)	39
9.8.3	Device Profile Specific Part (according to CiA DS-410)	40
9.8.3.1	Resolution (6000h).....	40
9.8.3.2	Inclination values axial (610h) / Inclination values longitudinal and lateral (6010h and 6020h).....	40
9.8.3.3	Operating Parameters (6011h and 6021h).....	40
9.8.3.4	Zero Point Adjustment for perpendicular angles: Preset Value, Offset Value, Differential Offset Value (60x1/2/3h)	41
9.9	Emergency Objects.....	41
9.10	Failure monitoring	42
9.10.1	Nodeguarding / Lifeguarding	42
9.10.2	Heartbeat	43
9.11	LSS: Layer Setting Service (according to CiA DSP-305).....	43
9.11.1	Setting of Node-ID and Baud Rate	43
9.12	Automatic Baud Rate Detection (according to CiA AN-801).....	44
9.13	Status LED (according to CiA DR-303-3).....	44
10	Functional Description SAE J1939 Interface.....	45
10.1	Message format	45
10.2	Device name and address	45
10.3	Process data (Transmit PGNs).....	46
10.4	PGN Mapping.....	49
10.5	Sensor configuration	50
10.5.1	Examples SAE J1939 communication.....	54
10.5.2	Status byte description	54
11	Maintenance and Service	55
11.1	Calibration	55

11.2	Customer service	55
11.2.1	Reshipment.....	55
11.2.2	Support	55
11.2.3	Warranty and limitation of liability	55
12	Sensor configuration	56
12.1	Inclination sensor - Programming adapter	56
12.2	PC software ISDControl	57
13	Ordering Information	58

List of Tables

Table 1: Technical data	4
Table 2: M12 Plug Connector Pin Out CAN Bus	8
Table 3: M12 Female Connector Pin Out CAN Bus	8
Table 4: Filter selection low pass filter	10
Table 5: Filter selection fusion filter	11
Table 6: Extended configuration of the sensor fusion.....	12
Table 7: Status and Error Display through Status LED	14
Table 8: Format of the CAN Frames.....	14
Table 9: Statusbyte	15
Table 10: „Boot Up“ Message	15
Table 11: Supported FSC and Parameters of the Set Parameter Frames (Request)	17
Table 12: Function Codes and Parameters of the Reply Parameter Frames	18
Table 13: Device parameters default settings	19
Table 14: Request frame: inclination values (FSC = 00h)	19
Table 15: Reply frame: inclination values (FSC = 00h)	19
Table 16: CAN Identifier.....	22
Table 17: Restore Default Device Parameters	24
Table 18: Save Device Parameters	25
Table 19: Perform a software reset.....	25
Table 20: Calculation of the COB-IDs for Pre-defined Connection Set.....	28
Table 21: TPDO1 Default mapping 2-dimensional	29
Table 22: TPDO2 Default mapping.....	29
Table 23: TPDO3 Default mapping.....	29
Table 24: TPDO4 Default mapping.....	29
Table 25: Mappable objects.....	30
Table 26: Communication Parameters in the Object Dictionary.....	34
Table 27: Error Register (1001h)	35
Table 28: Manufacturer Status Register (1002h).....	35
Table 29: Error Entry in Pre-defined Error Field (1003h).....	36
Table 30: Transmit PDO – Transmission Type	36
Table 31: Manufacturer Specific Part of the Object Dictionary	38
Table 32: Filter selection.....	38
Table 33: Values for the sensor orientation	39
Table 34: Device Profile Specific Part of the Object Dictionary.....	40
Table 35: Operating Parameters (6011h and 6021h)	41
Table 36: Zero Point Adjustment.....	41
Table 37: Emergency Object	42
Table 38: Emergency Error Codes	42
Table 39: Emergency: Manufacturer Specific Error Field.....	42

Table 40: LSS Baud Rate Index according to CiA DSP-305	44
Table 41: Status and Error Display of the Status LED.....	44
Table 42: Transmit PGN 1 - 61459 Slope Sensor Information	47
Table 43: Transmit PGN 2 - 61481 Slope Sensor Information 2	47
Table 44: Transmit PGN 3 - 61482 Angular Rate Information	47
Table 45: Transmit PGN 4 - 61485 Acceleration Sensor	48
Table 46: Transmit PGN 5 – perpendicular angle.....	48
Table 47: Transmit PGN 6 - Euler angles	48
Table 48: Transmit PGN 7 - Quaternion	48
Table 49: Transmit PGN 8 - Acceleration	48
Table 50: Transmit PGN 9 - Angular rate.....	49
Table 51: Transmit PGN 10 - unfiltered acceleration.....	49
Table 52: Transmit PGN 11 - Gyro angle.....	49
Table 53: Status Bits in the PGN	49
Table 54: SAE J1939 proprietary B mapping signals	50
Table 55: Configuration parameters	54
Table 56: Read the firmware version of the sensor (device address 128)	54
Table 57: Activate sensor fusion (device address 128)	54
Table 58: Status byte	54
Table 59: Ordering information	58

List of Figures

Figure 1: Standard orientation z-up	5
Figure 2: Orientation z-down	5
Figure 3: Orientation y-up	5
Figure 4: Orientation y-down	5
Figure 5: Orientation x-up	5
Figure 6: Orientation x-down	5
Figure 7: Acceleration	6
Figure 8: Rotation rate	6
Figure 9: Euler angle, factory setting	6
Figure 10: Euler angle reversed	6
Figure 11: Mounting holes (dimensions in mm).....	7
Figure 12: internal circuit	9
Figure 13: Impulse response of the two low pass filters	10
Figure 14: Amplitude response of the two low pass filters	11
Figure 15: Operational Principle of the Cyclic Mode	20
Figure 16: CANopen structure	27
Figure 17: NMT State diagram	28
Figure 18: SDO Protocol – Access to Object Dictionary	31
Figure 19: SAE J1939 CAN-Identifier.....	45
Figure 20: Starter kit	56
Figure 21: PC software	57

1 Safety information

1.1 *Incoming inspection*

Unpack the device immediately after you received it and check the entire delivery for completeness. If transport damage is to be assumed, inform the delivery agent within 72 hours and keep the packaging for inspection. The device must only be transported in its original or equivalent packaging.

1.2 *Intended use*

The GEMAC Motus® *BLACKLINE* Xx is a device consisting of an electronic sensor and an integrated evaluation unit. The device is designed to determine inclinations in large-scale fixed installations of industrial automation as well as non-road mobile machinery or means of transport for persons or goods like agricultural and forestry machinery, utility vehicles or crane and hoisting technology.

GEMAC Chemnitz GmbH assumes no liability for losses or damages arising from the use of the product, either directly or indirectly. This applies in particular to use of the product that does not conform to this intended purpose and is not described in this document.

1.3 *Incorrect use*

The GEMAC Motus® *BLACKLINE* Xx is not a safety component according to the EC Machinery Directive (2006/42/EC). It must not be used in explosion hazardous areas. Any use that is not described in section 1.2 "Intended use" is prohibited. Any use of accessories that is not specifically approved by GEMAC Chemnitz GmbH is at your own risk.

1.4 *Requirements for the qualification of personnel*

The personnel who work on and with the GEMAC Motus® *BLACKLINE* Xx must be suitably authorized, trained, and sufficiently qualified. Skilled personnel refers to the following:

- Has received specialist training, which is backed up by additional knowledge and experience according to operation and service of the sensor and the respective application.
- Knows the relevant technical terms and regulations.
- Can appraise the work assigned to them, recognize potential hazards, and take suitable safety precautions.

2 Overview

2.1 Characteristics

- 6 axial inertial measurement unit with accelerometer and gyroscope
- Dynamic inclination sensor
 - independent of the local gravity field through 3D measurement
- Easy to handle parametrization with GEMAC programming tools
 - Intelligent sensor fusion algorithm, configurable for the application
 - configurable filter for vibration suppression
- High sampling rate and bandwidth
- High resolution (0.01°)
- High static accuracy independent of sensors orientation, model-dependent up to $\pm 0.1^\circ$
 - including compensated cross sensitivity
- Dynamic accuracy model-dependent up to $\pm 0,5^\circ$
 - including compensated cross sensitivity
- Comfortable CAN, CANopen or SAE J1939 interface
 - Baud rates from 10 kBit/s to 1 MBit/s
 - Automatic baud rate detection
- UV-resistant, impact-resistant plastic housing
- Wide input voltage range (7.5 - 36 V)
- Low power consumption
- Suitable for industrial use:
 - Temperature range: -40 °C to +85 °C
 - Degree of protection: IP65/67 and IP6K9K

The sensor is factory calibrated in all measuring axes to ensure high accuracy.

The compact and robust design makes the sensors a suitable angle measurement device in rough surroundings for different applications in industry and vehicle technology. Occurring accelerations caused by e.g. brake applications or cornering events are reliably filtered by an integrated fusion algorithm.

A simple configuration and putting into operation is possible by the digital interface.

2.2 Applications

- Agricultural and forestry machinery
- Construction machinery
- Crane and hoisting technology

3 Technical Data

General parameters ¹		XB6MP360-x		XC6MP360-x	
Measurement range	±90° (perpendicular angle) or ±180° (roll angle) ²				
Resolution	0.01°				
Static accuracy (including cross sensitivity)	typical	maximum	typical	maximum	
	±0.3°	±0.5°	±0.1°	±0.15°	
Dynamic accuracy (including cross sensitivity)	typ. ±0.5°				
Duration of suppression of external accelerations (configurable)	100 – 10000 ms				
Temperature coefficient (zero point)	typ. ±0.01 °/K		typ. ±0.0016 °/K		
General Parameters IMU		XB6MP360-x		XC6MP360-x	
	Acceleration sensor	Angular Rate sensor	Acceleration sensor	Angular Rate sensor	
Measurement range	±8 g	±250 °/s	±8 g	±250 °/s	
Resolution	0.244 mg	0.00875 °/s	0.244 mg	0.00875 °/s	
In run bias stability	-	typ. 5 °/h	-	typ. 5 °/h	
Angular random walk (ARW)	-	0.2°/h	-	0.2°/h	
Temperature coefficient (zero point)	typ. 0.2 mg/K	typ. 0.01 °/s/K	typ. 0.02 mg/K	typ. 0.01 °/s/K	
General Parameters					
Sampling rate	200 Hz				
Operating temperature	-40 °C to +85 °C				
Characteristics					
Current interface	Xx6MP360- C	Xx6MP360- O	Xx6MP360- J		
	CAN 2.0 A and B (11- and 29-Bit-ID) according to ISO 11898-2	CANopen according to CiA DS-301, Device profile CiA DSP-410	SAE J1939		
Data rates	10k, 20k, 50k, 100k, 125k, 250k, 500k, 800k Bit/s, 1 MBit/s automatic detection			125k, 250k Bit/s automatic detection	
Functions	Angle request, cyclical and synchronized outputs, parametrization, sensor fusion algorithm, digital filter (critically damped (default) or Butterworth lowpass, 8th order), configuration via digital interface				
Electrical parameters					
Supply voltage	7.5 ... 36 VDC				
Current consumption	approx. 12 mA @ 24 V				
Necessary overcurrent protective device	400 mA ³				
Maximum output current	350 mA				
Mechanical parameters					
Connection	2 x sensor connector 5-pole M12 (male + female, loop through connection)				
Degree of protection	IP65/67 - IP6K9K ⁴				
Dimensions / Weight	121 mm x 66 mm x 30 mm / approx. 200 g				

- 1 All indicated angle accuracies are valid after a running time of 10 minutes at 25 °C, absolute calibration accuracy (at 25 °C): ±0.05°.
- 2 Up to 2 measuring axes with configurable orientation
- 3 The maximum temperature range of 85 °C is only valid for the Sx2MP360-I sensors with a minimum load resistance of 250 Ω and a maximum output current of 20 mA.
- 4 Only in connection with article no. 1404066 from Phoenix Contact GmbH and a tightening torque of 0.4 Nm.

Reliability according to EN ISO 13849-15		
	xB6MP360-x	XC6MP360-x
MTTF	644 years	491 years
MTTFd	1240 years	912 years
CE conformity		
EC Directives		
RL 2014/30/EU	Harmonisation of the laws of the Member States relating to electromagnetic compatibility	
RL 2011/65/EU	Restriction of the use of certain hazardous substances in electrical and electronic equipment	
Harmonized standards		
DIN EN ISO 13766-1:2019-04 ⁵	Earth-moving machinery and construction machinery - Electromagnetic compatibility of machinery with internal electrical system - Part 1: General EMC requirements under typical EMC environmental conditions (ISO 13766-1:2018)	
DIN EN IEC 63000:2019-05	Technical documentation for the assessment of electrical and electronic products with respect to the restriction of hazardous substances	

Table 1: Technical data

5 This product is a standard product and no safety part in accordance with the machinery directive. The calculation is based on an average environment temperature of 40 °C and a usage of 8760 h/a.

6 A voltage limitation of the load shedding of 58 V is assumed (see Figure 9. ISO 16750-2:2012).

4 Mounting position / orientation of the measuring axes

The sensor is delivered with the measuring axes shown in Figure 1. The orientation of the measuring axes can be changed via the digital interface and flexibly adapted to the customer-specific application. The orientations shown in Figure 1 to Figure 6 can be configured.



Figure 1: Standard orientation z-up

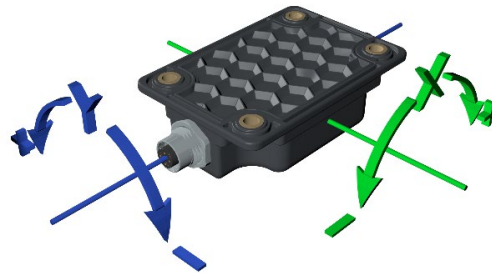

Figure 2: Orientation z-down

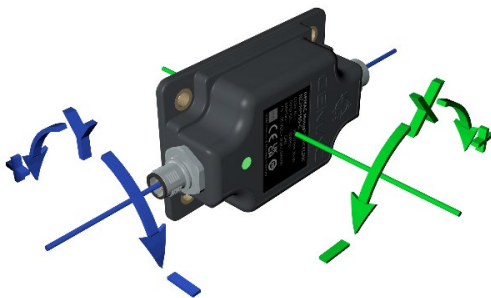

Figure 3: Orientation y-up

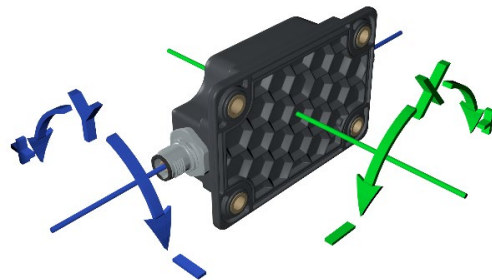

Figure 4: Orientation y-down

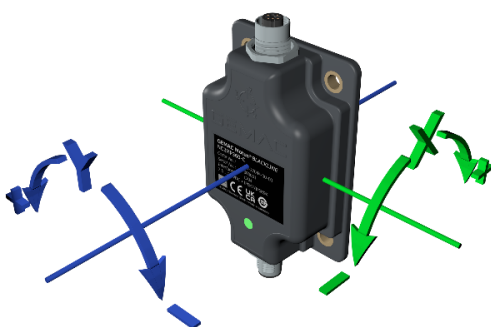

Figure 5: Orientation x-up

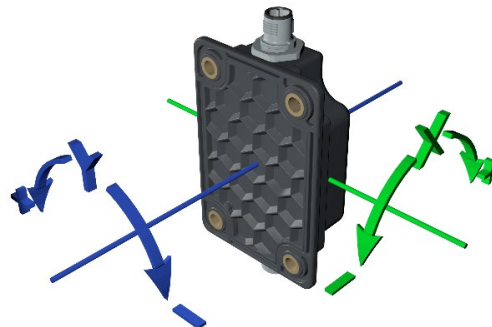

Figure 6: Orientation x-down

The sensor also offers the option of automatically determining the current orientation on command. Information on this can be found in the chapters of the respective interface description.

With standard alignment, the acceleration and angular rate values are output according to the measuring axes shown in Figure 9 and Figure 10. With the other orientations, the measuring axes change in the same way as shown in Figure 2 to Figure 6.

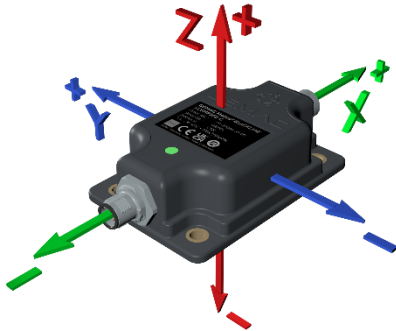

Figure 7: Acceleration

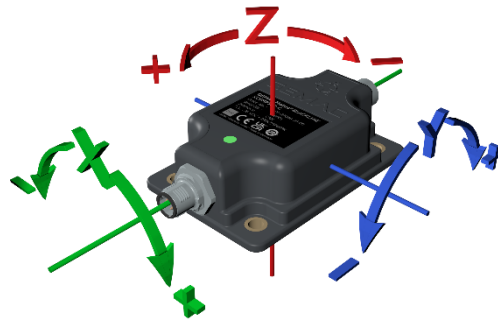

Figure 8: Rotation rate

4.1 Swap the measuring axes

In addition to the configuration of the orientation, the sensor offers the option of swapping the measuring axes for the angle output. This is particularly helpful when using the Euler angles (pitch and roll) in order to make optimum use of the different value ranges (pitch $\pm 90^\circ$, roll $\pm 180^\circ$).

The exchange of the measuring axes is implemented internally as a rotation of the coordinate system. Therefore, the sign of the roll angle changes when swapped. The effect is shown in Figure 9 and Figure 10.



Figure 9: Euler angle, factory setting



Figure 10: Euler angle reversed

5 Mounting

5.1 Fixation

The Sensor has to be screwed in place by using 4 hexagon socket screws M5 according to DIN 912 A2 and 4 hexagon nuts M5 according to DIN 934 with a torque of 3 Nm in a manner, that one full thread of the screw is overlapping minimum.

5.2 Position of mounting holes

Holes to mount the sensor (Figure 11) are situated in the base plate of the sensor.

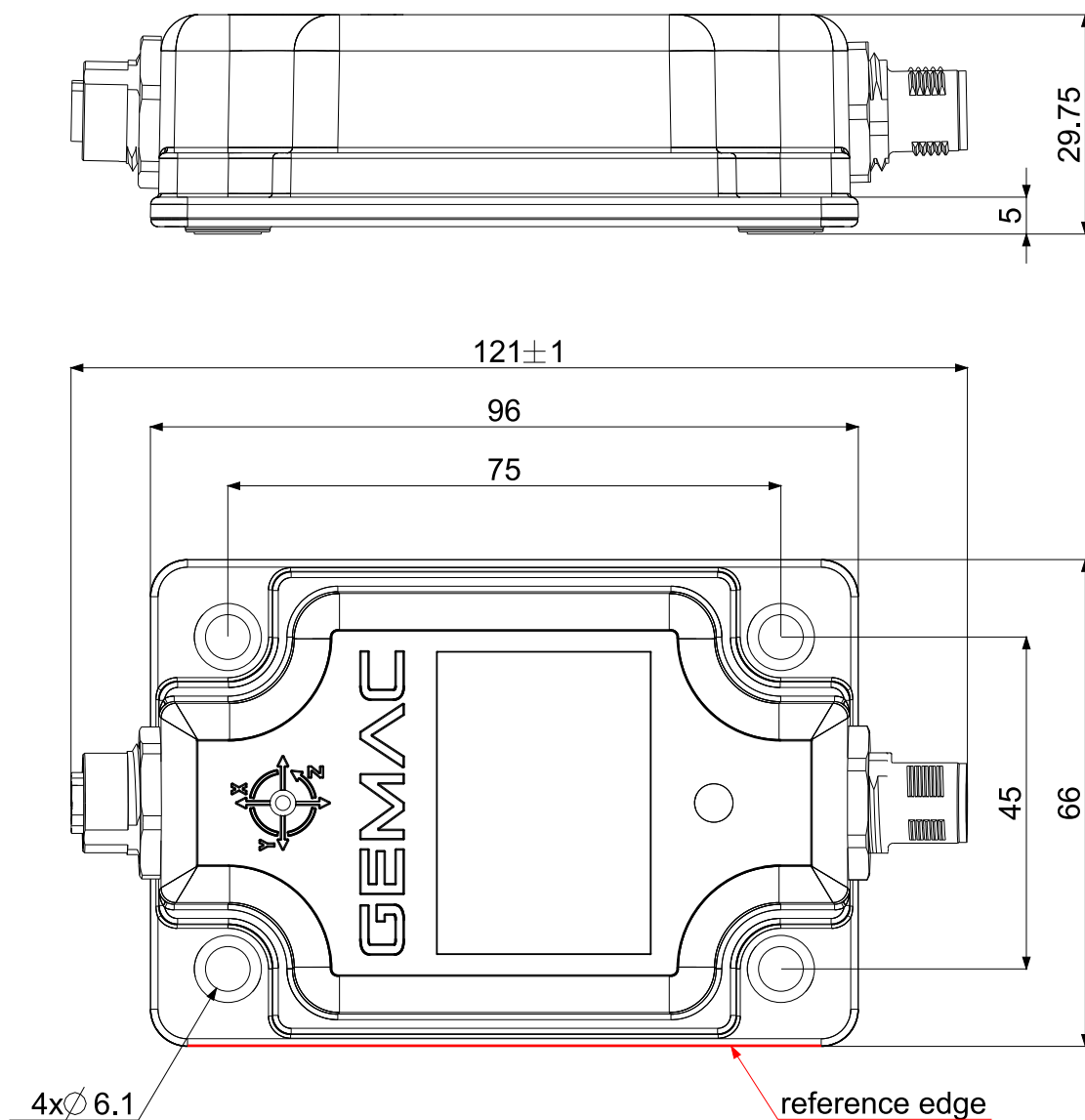

Figure 11: Mounting holes (dimensions in mm)

6 Connection

6.1 General connection information

The sensor is equipped with a 5-pole round male connector M12 (A-coded) according to IEC 61076-2-101. There is an additional 5-pole round female connector (A-coded) available. The voltage supply is forwarded from the male connector to the female connector. That allows to power further sensors with one cable harness. It is necessary to ensure that that current draw of all connected devices is less than 350 mA total.

A shielded cable must be used. The screen on the power supply must be connected to ground.

6.2 Requirements to the voltage supply

The voltage supply has to be dimensioned in a manner that the voltage values given in Table 1 are not exceeded.

The power supply has to be protected with a suitable fuse, that guarantees that a current of more than **400 mA can flow for 3 s maximum**.

6.3 Connector Pin Out

The pin allocation fulfills CiA DR-303-1 (Table 2 and Table 3).

Pin	Signal	Allocation
1	CAN_SHLD	Shield
2	V+	Supply voltage (+24 V)
3	V-	GND / 0 V / V-
4	CAN_H	CAN_H bus line
5	CAN_L	CAN_L bus line

Table 2: M12 Plug Connector Pin Out CAN Bus

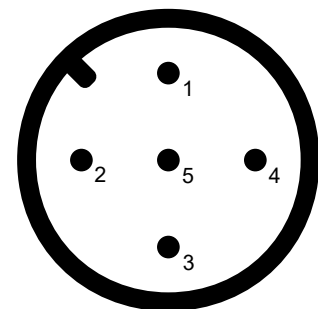

(View from the outside)

Pin	Signal	Allocation
1	CAN_SHLD	Shield
2	V+	Supply voltage (+24 V)
3	V-	GND / 0 V / V-
4	CAN_H	CAN_H bus line
5	CAN_L	CAN_L bus line

Table 3: M12 Female Connector Pin Out CAN Bus

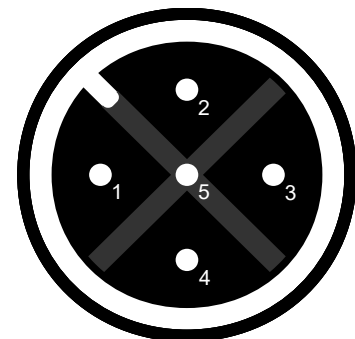

(View from the outside)

6.4 Internal circuit

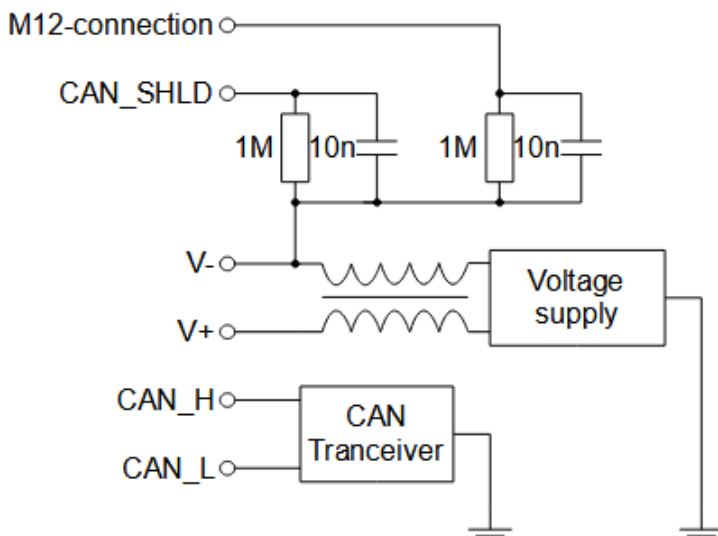

Figure 12: internal circuit

6.5 Bus-Termination Resistor

The sensor does **not** contain an internal termination resistor.

7 Functional description

7.1 Low pass filter

The sensor uses an indirect measuring method based on gravitational acceleration. As inherent to their functional principle, external accelerations, as they can occur due to vibrations, interfere with the function of the sensor.

The sensor offers the possibility of making the output angle values more robust against disturbing vibrations or external accelerations. Two low pass filters are available in the sensor, that can be selected according to the application of the sensor.

With the aid of the parameterizable low pass filter (Butterworth or critically damped) of eighth order, parasitic oscillations / vibrations up to 0.1 Hz can be suppressed.

Filter	Adjustable frequency range	Applications
Butterworth	0.1 Hz ... 25 Hz	Static inclination measurement with high damping to vibration
Critically damped	0.1 Hz ... 8 Hz	Inclination measurement in applications that requires a certain dynamism, without overshoot at angle changes with good damping

Table 4: Filter selection low pass filter

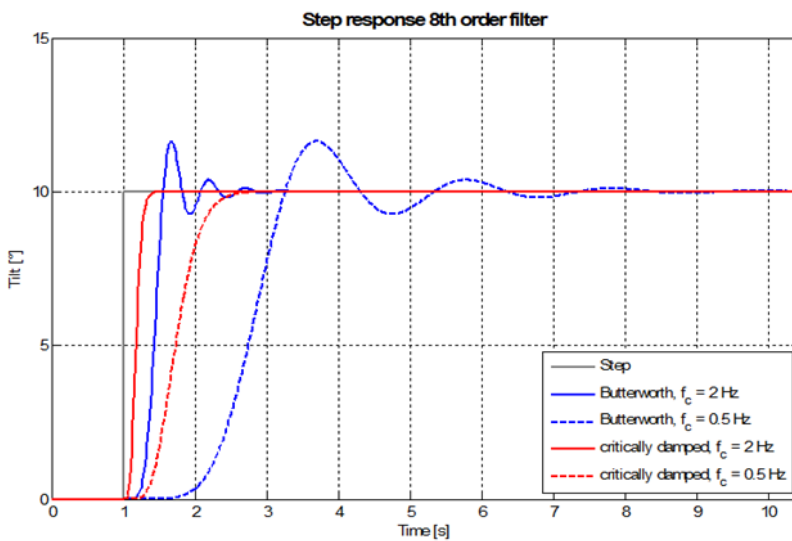

Figure 13: Impulse response of the two low pass filters

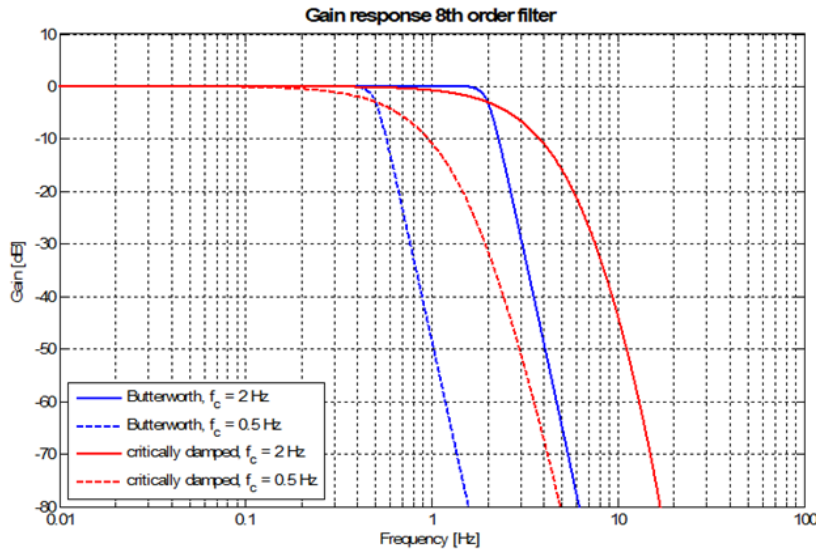

Figure 14: Amplitude response of the two low pass filters

7.2 Sensor fusion filter

7.2.1 Functionality

External accelerations that occur, for example, when vehicles brake or corner, cannot be reliably suppressed by the low pass filter.

In addition to the earth's gravitational field, the sensor fusion filter uses the rotation rate information of a gyroscope as a measured variable. Thus, external accelerations can be suppressed without the angle information being subject to a noticeable time delay.

The acceleration signal used for the sensor fusion is first preprocessed with the filter described in chapter 7.1 „Low pass filter“.

The sensor fusion works by default with an adaptive configuration, that means, the filter settings are dynamically adapted to the current state of movement of the sensor. This results in an optimal damping of external disturbances both in very dynamic applications and at rest.

Filter	Adjustable range	Applications
Sensor fusion	100 ms ... 10 s	Dynamic applications, measurements during acceleration/braking or cornering, measurement without time delay of the signal

Table 5: Filter selection fusion filter

7.2.2 Advanced configuration of the sensor fusion filter

The dynamic adaptation of the sensor fusion filter can be deactivated if necessary. In addition, the value of the damping factor for suppression of external accelerations can be adjusted (see Table 6).

The configuration can be used to avoid a drift of the output values in very dynamic or permanently moving systems. For customer-specific configuration of the sensor for special applications, please contact GEMAC Chemnitz GmbH.

Configuration	Adjustable range	Description
Adaptive damping	Off (0) / On (1, default)	On: Automatic detection and damping of external accelerations activated with dynamic adjustment of the damping factor Off: Fixed damping factor for external accelerations is used permanently
Damping factor	0 ... 20 (default: 19)	0: minimum damping of external accelerations during sensor fusion 19: maximum damping 20: The angle is only calculated from gyro data, warning: drift of the output data is possible

Table 6: Extended configuration of the sensor fusion

7.2.3 Drift compensation of the rotation rate

The output data of the gyroscope in the sensor are offset-afflicted. In order to compensate for the variable offset, the sensor is equipped with an automatic drift compensation, which dynamically determines the offset when the sensor is not accelerating. It is also possible to deactivate the automatic compensation by means of a command or to trigger it manually. The offset is then determined within 2 seconds after the command. The sensor should stand still during this time.

8 Functional description of the CAN interface

8.1 *Orientation of the measuring axes*

The mounting position of the sensor and the measuring axes for the output of angle values can be configured using a configuration telegram (FSC = 2Dh). In addition, the orientation of the sensor can be automatically determined by a command and the measuring axes can be swapped. For more information, see Chapter 4 „Mounting position / orientation of the measuring axes“ and 8.12.5 “Configure measuring axes and orientation”.

8.2 *Zero Point Adjustment*

The zero point of the sensor can be adjusted (parameterized) for the angle output. This allows to set the zero position in the installed state of the sensor. For this purpose, the sensor has a memory for a zero point offset. Values entered here are added to the internally measured angle when the angle is output.

In case the current position should be set as zero point, the current measured inclination value must be set as negative value in the zero offset register. The sensor is able to perform this kind of Zero Point Adjustment itself (Automatic Zero Point Adjustment). Therefore the user has to send a telegram **without** parameters (OFX;OFY / FSC = 28h/29h - depending on sensor type, DLC = 1). The sensor then sets the current position at the time of reception of the telegram as negative value in the zero offset register.

8.3 *Digital filter*

The cut-off frequency is programmable by FSC = 27h (Set Parameter Frame). Values for CF (cut-off frequency) are allowed between 100 (= 0.1 Hz) and 25000/8000 (= 25 Hz/8 Hz). The filter type is selected with the parameter FT.







8.4 *Sensor fusion algorithm*

The sensor fusion of acceleration sensor and gyroscope can be activated or deactivated by FSC = 2Bh (Set Parameter Frame). The filter duration of the sensor fusion algorithm can be set in a range between 10 ms and 10 s. This parameter is equal to the maximum suppression time of external disturbances. The sensor fusion can be configured independent from the digital filter.

In the extended configuration, the adaptive damping, the damping factor and the dynamic drift compensation can also be configured using FSC = 2Ch (see chapter 8.12.7 “Configuration of Sensor Fusion”).

8.5 Status LED

The integrated two-color Status LED signals the current device state (Run LED, green) as well as CAN communication errors that might have occurred (Error LED, red). The color and the flashing frequency of the LED distinguish the different device states as shown in Table 7.

Configuration		
Run LED	LED state	Description
 ...	Off	The device is in state Reset or no power supply is connected
 ...	Flickering	Automatic baud rate detection is currently running (active)
 ...	On	The device is in normal operating state
Error LED	LED state	Description
 ...	Off	The device is in working condition
 ...	Single Flash	CAN Warning Limit reached
 ...	On	The device is in state Bus-Off





Legend:  LED off  LED on  LED flickering (50 ms an/aus) Duration of one state ( / ): 200 ms

Table 7: Status and Error Display through Status LED

8.6 Format of the CAN Frames

For reading and writing device parameters, and to output the data from the sensor, two CAN-IDs exists. One ID for receiving data/commands and another one to send the response/confirmation. These IDs are saved in an internal permanent memory (EEPROM) and can be configured freely. CAN 2.0 A (Standard Frame Format) as well as CAN 2.0 B (Extended Frame Format) are supported.

8.6.1 Data Part in the CAN Frame

The data part of all transmission and reception frames always contains a function select code (FSC) and additionally up to seven data bytes depending on the FSC. The length of the data part of the CAN frame is defined in the DLC field (Data Length Code). The general format of the data part is structured as follows:

Byte0	Byte1	Byte2	Byte3	Byte4	Byte5	Byte6	Byte7
FSC	D0/Status	D1	D2	D3	D4	D5	D6

Table 8: Format of the CAN Frames

- FSC: **F**unction **S**elect **C**ode – Function code (detailed description in the sections about the operation modes). Each frame of the sensor always contains the FSC of the preceding request as confirmation.
- D0-D7: Data bytes, depending on the function select code
- Status: Status information which is included in each frame output by the sensor (see section 8.6.2 „Status Byte (STATUS)“).

Frames which are transmitted to the sensor may contain further data bytes beyond the needed ones – those will be discarded. Frames sent by the sensor only contain the data bytes defined by the function select code.

8.6.2 Status Byte (STATUS)

Each frame sent by the sensor contains the recent status of the device in Byte1 (see Table 8) of the CAN frame. The status byte is structured as follows:

Bit7	Bit6	Bit5	Bit4	Bit3	Bit2	Bit1	Bit0
reserved	Accuracy Warning	reserved	reserved	CmdParam Error	EEPROM Error	Autobaud Detection	Default Param

Table 9: Statusbyte

- DefaultParam: The standard device parameters are set. This bit is reset only when a device parameter was changed to a value different from the factory parameters. The sensors are supplied with the standard device parameters, so this bit is set by default (refer to section 8.9 „Default Device Parameters“).
- AutobaudDetection: The baud rate is set to automatic detection (BR = 0) (refer to section 8.12.3 „Configuration of the Baud Rate“).
- EEPROMError: While reading/writing on the EEPROM an error occurred, for example data loss. The correct function of the sensor is no longer guaranteed. This bit is reset by reading the status byte (Set Parameter Telegram with FSC = 02h).
- CmdParamError: A received frame contained a command or parameter error (invalid FSC, too less data bytes, invalid values). This bit is also set if an error occurred in the execution of a function (for example writing/reading error on EEPROM). This bit is reset by reading the status byte (Set Parameter Frame with FSC = 02h).
- AccuracyWarning: If the maximum values for acceleration or rotation rate are exceeded, the accuracy of the sensor is limited. This bit resets automatically when the sensor operates under the specified conditions again.

8.7 Boot Up Message

After device reset (hardware or software reset) the sensor outputs a “boot up” message twice. With this the correct boot process is displayed and the Set-Parameter-ID is notified (CAN-ID on which the sensor can be parametrized). This frame contains the following information:

“Boot up” message after device reset: Reply-Parameter-ID (default ID: 301h)

FSC	D0	D1	D2	D3	D4	D5	D6
FFh	Status	SID0	SID1	SID2	SID3	SWV0	SWV1

Table 10: „Boot Up“ Message

- SID0-3: Set-Parameter-ID (see section 8.8 „Read/Write device parameters“)
- SWV0-1: Software version; Example: SWV0 = 0x44, SWV1 = 0x03 → Software version v3.44

8.8 Read/Write device parameters

All parameters like inclinations values, CAN-IDs, Baud Rate, Cyclic Time etc. can be set and requested via the **Set Parameter Frames** (Request frame). The sensor confirms each frame with a **Reply Parameter Frame** which also contains the requested data according to FSC. (Reply frame).

8.8.1 Set Parameter Frame

Table 11 shows all the supported function select codes and the parameters of a Set Parameter Frame.

FSC	D0	D1	D2	D3	D4	D5	D6	Description	
00h	-	-	-	-	-	-	-	Read dynamic angle values in perpendicular angle format (incl. cycle counter in cyclic mode)	
01h	-	-	-	-	-	-	-	Read static angle values in perpendicular angle format	
02h	-	-	-	-	-	-	-	Read status	
03h	-	-	-	-	-	-	-	Read product number and revision	
04h	-	-	-	-	-	-	-	Read serial number and software version	
0Ah	-	-	-	-	-	-	-	Read dynamic angle values in Euler angle format	
0Bh	-	-	-	-	-	-	-	Read static angle values in Euler angle format	
0Ch	-	-	-	-	-	-	-	Read acceleration data	
0Dh	-	-	-	-	-	-	-	Read unfiltered acceleration data	
0Eh	-	-	-	-	-	-	-	Read the angular rate	
0Fh	RW	PRESET_X	PRESET_Y	PRESET_Z				Read / write relative angle (gyro only)	
10h	-	-	-	-	-	-	-	Set-Parameter-ID	Read device parameters
11h	-	-	-	-	-	-	-	Reply-Parameter-ID	
12h	-	-	-	-	-	-	-	Sync-ID	
13h	-	-	-	-	-	-	-	Baud Rate	
14h	-	-	-	-	-	-	-	Automatic Bus-Off Recovery	
15h	-	-	-	-	-	-	-	Cyclic Time	
16h	-	-	-	-	-	-	-	Cyclic Mode	
17h	-	-	-	-	-	-	-	Cut-off Frequency Digital Filter, Filter selection	
18h	-	-	-	-	-	-	-	Zero Offset X	
19h	-	-	-	-	-	-	-	Zero Offset Y	
1Bh	-	-	-	-	-	-	-	Read sensor fusion configuration	
1Ch	-	-	-	-	-	-	-	Read configuration of sensor fusion 2	
1Dh	-	-	-	-	-	-	-	Read the mounting position / orientation	
20h	ID0	ID1	ID2	ID3	-	-	-	Set-Parameter-ID*	
21h	ID0	ID1	ID2	ID3	-	-	-	Reply-Parameter-ID*	
22h	ID0	ID1	ID2	ID3	-	-	-	Sync-ID*	
23h	BR	-	-	-	-	-	-	Baudrate*	
24h	ABOR	-	-	-	-	-	-	Automatic Bus-Off Recovery	
25h	ZYZ0	ZYZ1	-	-	-	-	-	Cyclic Time	

* Changes to communication parameters such as ID and Baud Rate will take effect after reboot.

FSC	D0	D1	D2	D3	D4	D5	D6	Description
26h	ZYM	-	-	-	-	-	-	Cyclic Mode
27h	FG0	FG1	FT	-	-	-	-	Cut-off Frequency Digital Filter, Filter selection
28h	OFX0	OFX1	-	-	-	-	-	Zero Offset X
29h	OFY0	OFY1	-	-	-	-	-	Zero Offset Y
2Bh	EN	FL0	FL1	-	-	-	-	Configuration sensor fusion
2Ch	ED	DG	DF	TDG	-	-	-	Configuration sensor fusion 2
2Dh	OR	OSW	AO	-	-	-	-	Configuration of mounting position / orientation
40h	'L'	'O'	'A'	'D'	-	-	-	Load default device parameters (factory defaults)
50h	'S'	'A'	'V'	'E'	-	-	-	Write device parameters in EEPROM
FFh	'R'	'E'	'S'	'E'	'T'	-	-	Software reset
FFh	-	-	-	-	-	-	-	Read alive frame ("Boot Up" Message)

Table 11: Supported FSC and Parameters of the Set Parameter Frames (Request)

8.8.2 Reply Parameter Frames

As confirmation to the correctly received Set Parameter Frame each Reply Parameter Frame contains the identical FSC. The error bits of the status byte indicate insufficient or invalid parameters or errors that occurred while writing into the nonvolatile memory (refer to section 8.6.2 „Status Byte (STATUS)“). The structure of the Reply Parameter Frames in dependence to the FSC is shown in Table 12.

FSC	D0	D1	D2	D3	D4	D5	D6	Description
00h	Status	ANGLE_X_D		ANGLE_Y_D		(CNT)		Read dynamic angle values in perpendicular angle format (incl. cycle counter in cyclic mode)
01h	Status	ANGLE_X_S		ANGLE_Y_S				Read static angle values in perpendicular angle format
02h	Status	-	-	-	-	-	-	Read status
03h	Status	PR0	PR1	PR2	PR3	RV0	RV1	Read product number and revision
04h	Status	SN0	SN1	SN2	SN3	SWV0	SWV1	Read serial number and software version
0Ah	Status	PITCH_D		ROLL_D		-	-	Read dynamic angle values in Euler angle format
0Bh	Status	PITCH_S		ROLL_S				Read static angle values in Euler angle format
0Ch	Status	ACC_X		ACC_Y		ACC_Z		Read acceleration data
0Dh	Status	ACC_UNF_X		ACC_UNF_Y		ACC_UNF_Z		Read unfiltered acceleration data
0Eh	Status	AR_X		AR_Y		AR_Z		Read the angular rate
0Fh	Status	GYRO_ANG_X		GYRO_ANG_Y		GYRO_ANG_Z		Read / write relative angle (gyro only)
10h	Status	ID0	ID1	ID2	ID3	-	-	Set-Parameter-ID
11h	Status	ID0	ID1	ID2	ID3	-	-	Reply-Parameter-ID
12h	Status	ID0	ID1	ID2	ID3	-	-	Sync-ID
13h	Status	BR	-	-	-	-	-	Baud Rate
14h	Status	ABOR	-	-	-	-	-	Automatic Bus-Off Recovery
15h	Status	ZYZ0	ZYZ1	-	-	-	-	Cyclic Time
16h	Status	ZYM	-	-	-	-	-	Cyclic Mode
17h	Status	FG0	FG1	FT	-	-	-	Cut-off Frequency Digital Filter, Filter selection
18h	Status	OF0 OFX0	OF1 OFX1	-	-	-	-	Zero Offset X

Read device parameters

FSC	D0	D1	D2	D3	D4	D5	D6	Description
19h	Status	OFY0	OFY1	-	-	-	-	Zero Offset Y
1Bh	Status	EN	FL0	FL1	-	-	-	Configuration sensor fusion filter
1Ch	Status	ED	DG	DF	-	-	-	Configuration sensor fusion filter 2
1Dh	Status	OR	OSW	-	-	-	-	Configuration of mounting position / orientation
20h	Status	-	-	-	-	-	-	Set-Parameter-ID*
21h	Status	-	-	-	-	-	-	Reply-Parameter-ID*
22h	Status	-	-	-	-	-	-	Sync-ID*
23h	Status	-	-	-	-	-	-	Baud Rate*
24h	Status	-	-	-	-	-	-	Automatic Bus-Off Recovery
25h	Status	-	-	-	-	-	-	Cyclic Time
26h	Status	-	-	-	-	-	-	Cyclic Mode
27h	Status	-	-	-	-	-	-	Cut-off Frequency Digital Filter, Filter selection
28h	Status	-	-	-	-	-	-	Zero Offset X
29h	Status	-	-	-	-	-	-	Zero Offset Y
2Bh	Status	-	-	-	-	-	-	Configuration sensor fusion filter
2Ch	Status	-	-	-	-	-	-	Configuration sensor fusion filter 2
2Dh	Status	OR	OSW	AO	-	-	-	Configuration of mounting position / orientation
40h	Status	-	-	-	-	-	-	Load default device parameters (factory defaults)
50h	Status	-	-	-	-	-	-	Save device parameters in EEPROM
FFh	Status	Set-Param ID	Set-Param ID	Set-Param ID	Set-Param ID	SWV0	SWV1	Alive frame ("Boot Up" Message) Software reset (2 messages with FSC = FFh)

Write device parameters

Table 12: Function Codes and Parameters of the Reply Parameter Frames

8.9 Default Device Parameters

The sensor is delivered with the default device parameters shown in Table 13. These can be re-stored by a Set Parameter Frame with FSC = 40h (see section 8.8 „Read/Write device parameters“).

Parameter	Default Value	Description
Set-Parameter-ID	300h	CAN 2.0 A Standard Frame
Reply-Parameter-ID	301h	CAN 2.0 A Standard Frame
Sync-ID	100h	CAN 2.0 A Standard Frame
Baud Rate (BR)	0	Automatic Baud Rate Detection
Automatic Bus-Off Recovery	0	deactivated
Cyclic Time (CYT)	250	250 ms
Cyclic Mode (CYM)	0	deactivated
Mounting position / orientation	0	z-up
Swap measuring axes	0	deactivated
Cut-off Frequency (CF); filter type	5000; 2	5000 mHz = 5 Hz; critically damped filter

* Changes to communication parameters such as ID and Baud Rate will take effect after reboot.

Parameter	Default Value	Description
Sensor fusion; suppression time	1; 5000	Sensor fusion activated, 5000 ms = 5 s
Dynamic gyro offset correction	1	activated
Adaptive damping; Damping factor	1; 19	activated; maximum damping with sensor fusion
Zero Offset	0	Off

Table 13: Device parameters default settings

These default settings will also be set if invalid device parameters are read from the nonvolatile memory after device reset. If the default settings have been restored this is displayed by the status bit STATUS: DefaultParam = 1.

8.10 Transfer of the inclination values (perpendicular angle)

For the transfer of the inclination values the sensor supports following modes:

- Polling Mode
- Synchronous Mode
- Cyclic Mode

All three modes are active at any time and usable at the same time. Mode-switching is not necessary.

8.10.1 Polling Mode

The polling mode is always available. The inclination value(s) of the sensor can be requested via a **Set Parameter Frame**. The sensor replies to that frame via a **Reply Parameter Frame**. Both frames are structured as follows:

FSC	D0	D1	D2	D3	D4	D5	D6
00h	-	-	-	-	-	-	-

Table 14: Request frame: inclination values (FSC = 00h)

FSC	Status	D1	D2	D3	D4	D5	D6
00h	Status	AngleX0	AngleX1	AngleY0	AngleY1	-	-

Table 15: Reply frame: inclination values (FSC = 00h)

AngleX/Y0/1: Angle value of the X/Y-axis
 Format: 16 bit signed value, complement on two
 Conversion: Value / 100 = angle value

8.10.2 Synchronous Mode

The synchronous transmission is used to receive inclination values from more than one sensor at the same time. Therefore the sensor provides a synchronization frame (Default: Sync-ID = 100h). The synchronization frame is a broadcast message to all CAN nodes **without** user data (DLC = 0). This synchronization frame is transmitted from a bus node (usually the master) cyclically at fixed intervals. The sensor reads its

current angle values on receipt of the Sync message and sends the data directly afterward as soon as the bus allows this. The reply frame to a synchronization frame is the same as in polling mode (Table 15).

8.10.3 Cyclic Mode

The sensor supports the cyclical transmission of the recent position (angle position) after the expiration of a defined time interval. This operation mode can be (de)activated separately and the needed time interval (Cyclic Time) can be parametrized freely. Corresponding to the operational principle shown in Figure 15 the sensor outputs the recent position value in periodical intervals (Cyclic Time) with a Reply Parameter Frame as in the polling mode with additional counter in the following data bytes (Table 15). This 16-bit counter is increased after the end of the set Cycle Time - regardless of whether the telegram was sent or not. Thus, the temporal relation in case of lost frames can be restored.

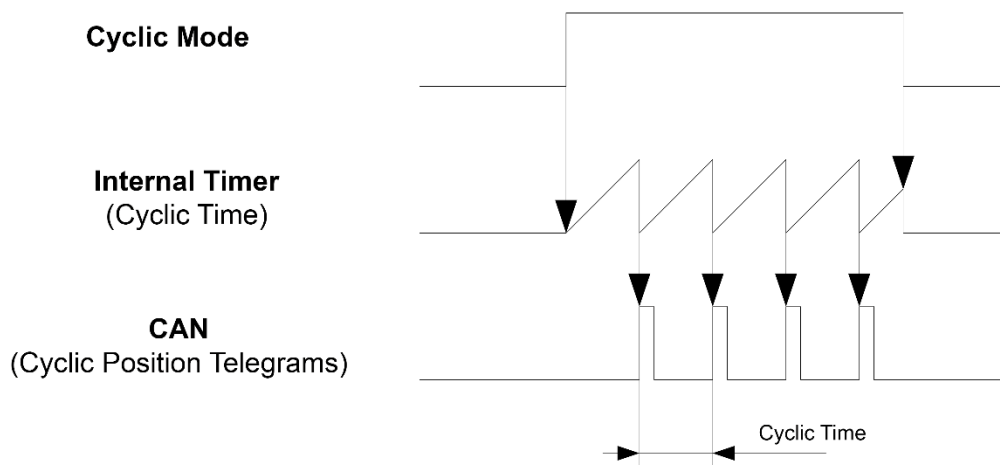

Figure 15: Operational Principle of the Cyclic Mode

8.11 Transfer of alternative output values

8.11.1 Euler-Angles

Using FSC 0Ah, the Euler-Angles Pitch and Roll can be read. The Pitch angle equals the inclination x-axis of the sensor (measurement range $\pm 90^\circ$). The Roll angle is the rotation angle around the x-axis (measurement range $\pm 180^\circ$).

The value for rotation in the horizontal plane (Yaw or heading) is not transmitted because it is not detectable by the Accelerometer.

The accuracy of Roll is reduced in the pitch $\sim 90^\circ$ or pitch $\sim -90^\circ$ range. At precisely 90° , the Roll movement corresponds to the rotation in the horizontal reference plane (= Yaw, Gimbal-Lock). In this range, the output of the roll angle is undefined.

FSC 0Ah outputs dynamic angles, which are calculated by the parameterizable fusion filter (FSC 2Bh) from filtered acceleration (FSC 0Ch) and gyro data (FSC 0Eh). FSC 0Bh outputs static angles, which is calculated only based on the filtered acceleration data.

Format: 16 bit signed value
 Conversion: value/100 = angle value

8.11.2 Angular Rate output (Gyro sensor raw data)

With the set parameter telegram FSC 0Eh, the rotation rates of all three axes of the gyro sensor queried.

Format: 16 bit signed value
 Conversion: value*7/800 = angular rate in °/s (measurement range ±250°/s)

8.11.3 Transfer of acceleration values

FSC 0Dh outputs the acceleration values of all three axes of the sensor. FSC 0Dh contains the filtered acceleration values, which calculated with the parameterizable low pass filter (FSC 27h). With FSC 0Ch, the acceleration data can be output unfiltered.

Format: 16bit signed value
 Conversion: value/4096 = acceleration in g (measurement range ±8g)

8.11.4 Output of relative angles (gyro angles)

The sensor offers the possibility to integrate the rotation rate information with an exact internal time stamp to angle values. These angles do not contain any information about the absolute value of the inclination of the sensor and describe the relative rotation of the sensor in the axes x, y, and z. When the sensor starts, the angles X and Y initialize with the inclination value; the angle Z initializes with 0. The drift of the gyro sensor influences the angle values. By writing this telegram, the angle values can set to a value between -180.00 and 179.99 degrees at any time.

RW	0: Read gyro angle	
	1: Write gyro angle,	with telegram length = 2 the angles are all set to 0
		with telegram length = 8 the preset values are used
PRESET_X	Default angle X-axis, format 16bit signed, value range -18000 to 17999	
PRESET_Y	Default angle Y-axis, format 16bit signed, value range -18000 to 17999	
PRESET_Z	Default angle Z-axis, format 16bit signed, value range -18000 to 17999	

The sensor responds to this telegram with a reply parameter telegram 0Fh, which contains the current or set angle values.

8.12 Configuration of the sensor

8.12.1 Configuration of Cyclic Mode

FSC	D0	D1	D2	D3	D4	D5	D6
25h	ZYZ0	ZYT1	-	-	-	-	-
26h	ZYM						

CYZ0/1: Cyclic Time in ms
 Format: 16bit unsigned integer value (1 ... 65535)

CYM: (De)activate Cyclic Mode
 = 0 → Cyclic Mode deactivated
 = 1 → Cyclic Mode activated

The section 8.10.3 „Cyclic Mode“ contains a detailed description of the usage of the Cyclic Mode.

8.12.2 Configuration of the CAN Identifier

FSC	D0	D1	D2	D3	D4	D5	D6
20h 21h 22h	ID0	ID1	ID2	ID3	-	-	-

ID0-3: CAN Identifier (ID), 11-Bit-ID (CAN 2.0 A) or 29-Bit-ID (CAN 2.0 B)
 Format: 32 bit value with the following structure:

ID3								ID2								ID1								ID0							
7	6	5	4	3	2	1	0	7	6	5	4	3	2	1	0	7	6	5	4	3	2	1	0	7	6	5	4	3	2	1	0
0	-															11-Bit-ID (CAN 2.0 A)															
1	-	29-Bit-ID (CAN 2.0 B)																													

Table 16: CAN Identifier

Example: CAN-ID = 361h (29-Bit-ID, CAN 2.0 B)
 ID0 = 61h, ID1 = 03h, ID2 = 00h, ID3 = 80h

If a CAN-ID is set newly, it must not be used by another frame type. If this occurs the error bit STATUS:CmdParamError is set in the Reply Parameter Frame and the CAN-ID is refused.

8.12.3 Configuration of the Baud Rate

FSC	D0	D1	D2	D3	D4	D5	D6
23h	BR	-	-	-	-	-	-

BR: Code of a Baud Rate
 Format: 8bit unsigned integer value (0 ... 10)
 Code: 0: Automatic Baud Rate Detection
 1: 10 kBit/s 2: 20 kBit/s 3: 50 kBit/s
 4: 100 kBit/s 5: 125 kBit/s 6: 250 kBit/s
 7: 500 kBit/s 8: 800 kBit/s 9: 1 Mbit/s

8.12.4 Configure Automatic Bus-Off Recovery

FSC	D0	D1	D2	D3	D4	D5	D6
24h	ABOR	-	-	-	-	-	-

ABOR: Enable/Disable Automatic Bus-Off Recovery

= 0 Enable Automatic Bus-Off Recovery (Device remains in the state Bus-Off)

= 1 Disable Automatic Bus-Off Recovery (Device starts up again)

8.12.5 Configure measuring axes and orientation

FSC	D0	D1	D2	D3	D4	D5	D6
2Dh	OR	OSW	AO	-	-	-	-

OR: Write sensor orientation (refer chapter 4 "Mounting position / orientation of the measuring axes" and chapter 8.1 „Orientation of the measuring axes “)

0 z-up (default value)

1 z-down

2 y-up

3 y-down

4 x-up

5 x-down

OSW: 0 Measuring axes standard assignment (default value)

1 Orientation of the measuring axes swapped

AO: 1 write to carry out automatic orientation determination, the value of OR is thereby ignored, the reply parameter telegram contains the determined orientation

8.12.6 Configuration Cut-off frequency of the low pass filter

FSC	D0	D1	D2	D3	D4	D5	D6
27h	FG0	FG1	FT	-	-	-	-

FG0/1: Cut-off Frequency in mHz when selecting the Butterworth or critically damped filter

Format: 16 bit unsigned integer value (100 ... 25000/8000)

FT: 0 Low pass filter deactivated

1 Butterworth Filter activated (maximum filter frequency = 25000 mHz)

2 Critically Damped Filter activated (maximum filter frequency = 8000 mHz)

The section 7.1 „Low pass filter“ contains a detailed description.

8.12.7 Configuration of Sensor Fusion

FSC	D0	D1	D2	D3	D4	D5	D6
2Bh	EN	FL0	FL1	-	-	-	-

Functional description of the CAN interface

- EN: 0 Sensor Fusion deactivated
 1 Sensor Fusion activated (factory setting)
- FL: duration of suppression of external disturbances in milliseconds at activated sensor fusion algorithm
 Format: 16-Bit unsigned integer value (100 ... 10000)

FSC	D0	D1	D2	D3	D4	D5	D6
2Ch	ED	DG	DF	TDG	-	-	-

- ED: 0 Adaptive damping deactivated
 1 Adaptive damping activated (default value)
- DG: 0 Dynamic gyro drift compensation deactivated
 Dynamic gyro drift compensation activated (default value)
- DF: Damping factor; Minimum damping value 0 to maximum damping 19
 20: only gyro data is used for angle calculation; Warning: drift possible
- TDG: Carry out manual drift compensation (duration: 2 seconds)

8.12.8 Configuration of Zero Point Adjustment

FSC	D0	D1	D2	D3	D4	D5	D6
28h	OFX0	OFX1	-	-	-	-	-
29h	OFY0	OFY1	-	-	-	-	-

OFX/OFY: Type: Zero Offset X/Y

Format: 16 bit signed value (-18000 ... +17999)

The section 8.2 „Zero Point Adjustment“ contains a detailed description.

8.12.9 Restoration of Default Device Parameters

FSC	D0	D1	D2	D3	D4	D5	D6
40h	'L'	'O'	'A'	'D'	-	-	-

The sensor can be reset to default device parameters by writing the signature "LOAD" to the sensor (FSC = 40h). Thus the default parameters with the exception of the ID and the Baud Rate are immediately active again. After a software reset of the sensor or a hardware reset, the factory parameter of the IDs and the baud rate take effect again.

D0	D1	D2	D3
'L'	'O'	'A'	'D'
4Ch	4Fh	41h	44h

Table 17: Restore Default Device Parameters

The section 8.9 „Default Device Parameters" contains a detailed description.

8.12.10 Save Device Parameters

FSC	D0	D1	D2	D3	D4	D5	D6
50h	'S'	'A'	'V'	'E'	-	-	-

If parameters are changed in the sensor, they take effect immediately, except for the IDs and the Baud Rate. Thus the new parameters are still active after a reset, these must be stored in the internal non-volatile memory. This is done by writing the signature "SAVE" on the FSC = 50h.

D0	D1	D2	D3
'S'	'A'	'V'	'E'
53h	41h	56h	45h

Table 18: Save Device Parameters

8.12.11 Perform a software reset

FSC	D0	D1	D2	D3	D4	D5	D6
FFh	'R'	'E'	'S'	'E'	'T'	-	-

A software reset of the sensor is carried out by sending the telegram with FSC = FFh. The sensor then restarts and transmits an alive (bootup) telegram. After a software reset of the sensor, unsaved parameters are discarded.

D0	D1	D2	D3	D4
'R'	'E'	'S'	'E'	'T'
52h	45h	53h	45h	54h

Table 19: Perform a software reset

9 Functional Description CANopen interface

9.1 Overview of Function

The sensor contains a standardized CANopen interface according to CiA DS-301 and a device profile according to CiA DSP-410. All measured values and parameters are accessible through the object dictionary (OD). The individual configuration can be saved in the internal permanent memory (EEPROM). The following CANopen functions are available:

- four transmission data objects (TPDO1 to TPDO4), dynamically mappable in four possible operating modes:
 - Individual request via remote transmit request message frame (RTR)
 - Cyclic transmission at defined intervals
 - Event-controlled transmission on inclination change (TPDO1)
 - Synchronous transmission after receiving a SYNC message frame
- One Service Data Object (Default SDO)
- Error messages by Emergency Object (EMCY) with support of the:
 - General Error Register
 - Manufacturer specific status register (Manufacturer Status)
 - List of errors (Pre-defined Error Field)
- Heartbeat and Nodeguarding / Lifeguarding monitoring mechanisms
- Store and load function of all parameters (Store and Load Parameter Field)
- Condition and error information by two-colored LED (according to CiA DR-303-3)

Further manufacturer and profile specific characteristics exist in addition to the CiA DS-301 functionality:

- Configurable cut-off frequency (low pass filter)
- Sensor fusion filter
- Configuration of the minimum angle change for TPDO1 transmit event
- Direction switch of the inclination value
- Configuration of the sensor orientation and swapping of the measuring axes
- Configurable zero point of the inclination value
- Setting of the Node-ID as well as the baud rate via LSS service according to CiA DSP-305
- Automatic baud rate detection according to CiA AN-801

9.2 CANopen Structure

CANopen is a CAN-based open protocol standard in automation and was standardized in association with “CAN in Automation” (CiA). Like virtually all field buses CANopen is based also on the ISO/OSI 7-layer model. The protocol makes use of the CAN bus as a transmission medium and defines the elements for network management, the use of the CAN identifier (message address), the temporal behavior on the bus, the type of data transfer and application profiles. This is to ensure that CANopen devices from different manufacturers can be combined.

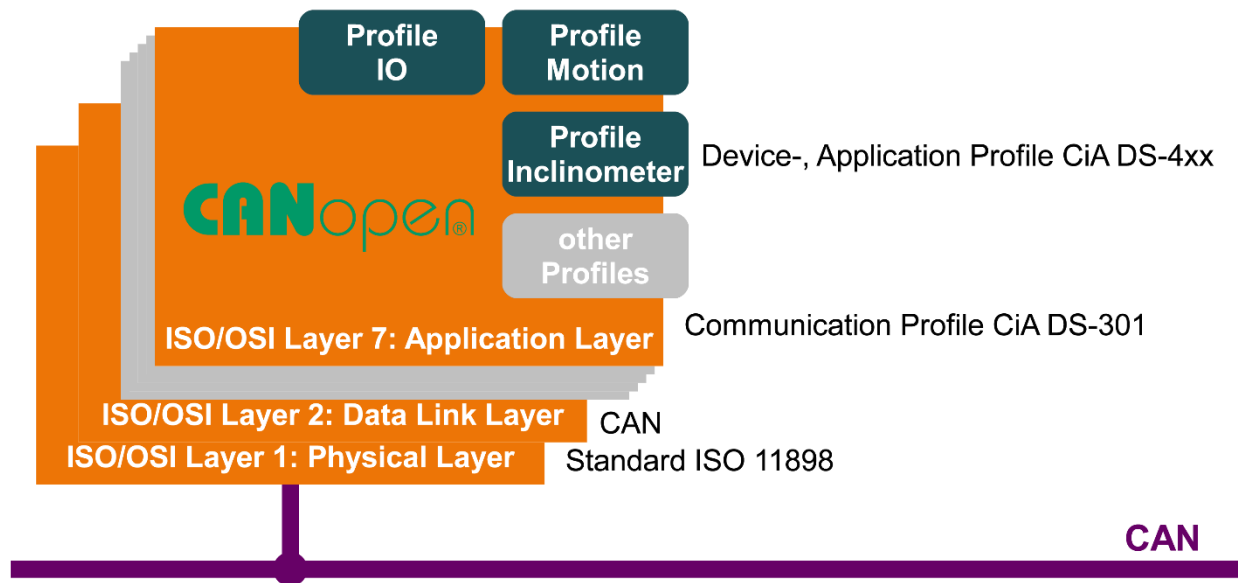

Figure 16: CANopen structure

CANopen describes the ISO / OSI layer 7 (application layer) as a communication profile that was specified in the CiA standard CiA DS-301. The standard defines the method of communication for all devices consistently. In addition, more device and application profiles for specific classes of devices and applications in the CiA standard DS-4xx are defined.

9.3 CANopen Device Model

The exchange of data between CANopen devices is realized via data objects. The CANopen communication profile thus provides for the following types of objects. The process data objects (PDO) are high-priority messages used for the exchange of process data. Access to the object dictionary of a device is done via the service data objects (SDOs). Network management objects are used to control the state machine of the CANopen device and to monitor the nodes. Furthermore, there are special objects for error messages (Emergency), Synchronization (SYNC) and time stamp. Every CANopen device has a CANopen object dictionary, in which the parameters for all CANopen objects are registered.

9.4 COB-IDs

The CAN identifier of the communication objects is determined according to the Pre-defined connection set at each reset (communication, application and hardware reset), depending on the selected Node-ID. Table 20 shows the calculation base with the default values (Node-ID = 10)

Communication object (COB)	Calculation of the COB-ID	Default value (Node-ID = 10)
NMT	0h	0h
SYNC	80h	80h
EMCY	80h + Node-ID	8Ah
TPDO1	180h + Node-ID	18Ah
TPDO2	280h + Node-ID	28Ah
TPDO3	380h + Node-ID	38Ah
TPDO4	480h + Node-ID	48Ah
Standard-SDO (Client > Server)	600h + Node-ID	60Ah
Standard-SDO (Server > Client)	580h + Node-ID	58Ah
Heartbeat	700h + Node-ID	70Ah

Table 20: Calculation of the COB-IDs for Pre-defined Connection Set

9.5 Network Management: NMT

Figure 17 shows the NMT state machine of a CANopen device. After **Initialization** the device automatically goes into the state **Pre-Operational**. The device sends a **Boot-Up Message**. In this state it can be configured via the object dictionary. The service data objects (SDO) are already active. The process data objects, however, are still locked.

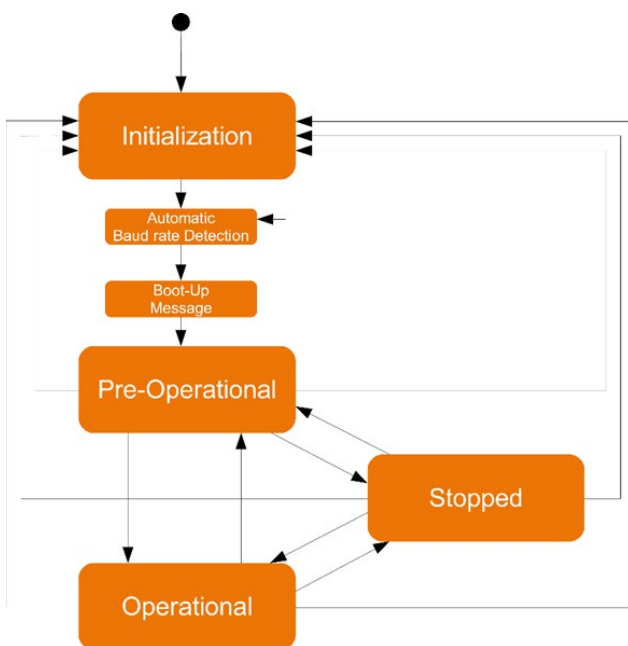

Figure 17: NMT State diagram

By sending the CAN message "Start Remote Node" the unit will go into the state **Operational**. Now the process data objects are active. In **Stopped** state, no communication with the exception of Nodeguarding and Heartbeat is possible.

By setting the Self-Starting-Device bit on object 1F80h, the sensor can be configured in such a way that it changes directly to the operational state after initialization. This enables e.g. a direct data output after starting up without further communication with the sensor.

9.6 Process Data: PDO (TPDO1 – TPDO4)

The sensor has two transmit process data objects (TPDO1 and TPDO4). TPDO1 contains the current values of inclination (perpendicular angle) by default. The PDO mapping of the measured values is dynamically adjusted. The default mapping is shown in Table 21.

Data part of the CAN Frame of the TPDO1							
Byte0	Byte1	Byte2	Byte3	Byte4	Byte5	Byte6	Byte7
perpendicular angle longitudinal (x axis, OV: 6010h)		perpendicular angle lateral (y axis, OV: 6020h)		unused			

Table 21: TPDO1 Default mapping 2-dimensional

The send process data object TPDO2 is disabled by default (valid bit of COB-ID set). The default mapping is shown in Table 22.

Data part of the CAN Frame of the TPDO2							
Byte0	Byte1	Byte2	Byte3	Byte4	Byte5	Byte6	Byte7
Euler angle Pitch (OV: 3100h:01h)		Euler angle Roll (OV: 3100h:02h)		unused			

Table 22: TPDO2 Default mapping

Data part of the CAN Frame of the TPDO3							
Byte0	Byte1	Byte2	Byte3	Byte4	Byte5	Byte6	Byte7
acceleration X (OV: 3102h:01h)		acceleration Y (OV: 3102h:02h)		acceleration Z (OV: 3102h:03h)		unused	

Table 23: TPDO3 Default mapping

Data part of the CAN Frame of the TPDO3							
Byte0	Byte1	Byte2	Byte3	Byte4	Byte5	Byte6	Byte7
angular rate X (OV: 3103h:01h)		angular rate Y (OV: 3103h:02h)		angular rate Z (OV: 3103h:03h)		unused	

Table 24: TPDO4 Default mapping

The following objects can be mapped to the TPDOs:

Index	Subindex	Description	Format	Resolution	Value range
3100h	1	Euler angle: Pitch	16bit signed	0.01 °/bit	-90.00 ... 90.00
3100h	2	Euler angle: Roll	16bit signed	0.01 °/bit	-180.00 ... 180.00
3101h	1	Quaternion: w	16bit signed	1/30000 /bit	-1 ... +1

Index	Subindex	Description	Format	Resolution	Value range
3101h	2	Quaternion: x	16bit signed	1/30000 /bit	-1 ... +1
3101h	3	Quaternion: y	16bit signed	1/30000 /bit	-1 ... +1
3101h	4	Quaternion: z	16bit signed	1/30000 /bit	-1 ... +1
3102h	1	Acceleration, x axis	16bit signed	1/4096 g/bit	-8 ... 8
3102h	2	Acceleration, y axis	16bit signed	1/4096 g/bit	-8 ... 8
3102h	3	Acceleration, z axis	16bit signed	1/4096 g/bit	-8 ... 8
3102h	4	Unfiltered acceleration: x axis	16bit signed	1/4096 g/bit	-8 ... 8
3102h	5	Unfiltered acceleration: y axis	16bit signed	1/4096 g/bit	-8 ... 8
3102h	6	Unfiltered acceleration: z axis	16bit signed	1/4096 g/bit	-8 ... 8
3103h	1	Angular rate, x axis	16bit signed	7/800 °/s/bit	-250 ... 250
3103h	2	Angular rate, y axis	16bit signed	7/800 °/s/bit	-250 ... 250
3103h	3	Angular rate, z axis	16bit signed	7/800 °/s/bit	-250 ... 250
3104h	1	Gyro angle: x axis	16bit signed	0.01 °/bit	-180.00 ... 180.00
3104h	2	Gyro angle: y axis	16bit signed	0.01 °/bit	-180.00 ... 180.00
3104h	3	Gyro angle: z axis	16bit signed	0.01 °/bit	-180.00 ... 180.00
3105h	1	Static perpendicular angle: x axis	16bit signed	0.01 °/bit	-90.00 ... 90.00
3105h	2	Static perpendicular angle: y axis	16bit signed	0.01 °/bit	-90.00 ... 90.00
3105h	3	Static Euler angle: Pitch	16bit signed	0.01 °/bit	-90.00 ... 90.00
3105h	4	Static Euler angle: Roll	16bit signed	0.01 °/bit	-180.00 ... 180.00
6010h	0	Perpendicular angle: x axis	16bit signed	0.01 °/bit	-90.00 ... 90.00
6020h	0	Perpendicular angle: y axis	16bit signed	0.01 °/bit	-90.00 ... 90.00
6511h	0	Temperature	8bit signed	1 °C / bit	-128 ... 127

Table 25: Mappable objects

9.6.1 PDO Communication Types

9.6.1.1 Individual Request (Polling)

The TPDOs (when activated) can be requested at any time by transmitting a remote-transmit request message (RTR) frame.

9.6.1.2 Cyclic Transmission

The configuration of the TPDOs 1 to 4 is done via the objects 1800h to 1803h.

Cyclic transmission of the TPDO is activated when the sub-index 05h (interval time in milliseconds) contains a value greater than 0, and the COB-ID at sub-index 01h is valid (bit 31 deleted). Furthermore, the sub-index 02h (transmission type) must contain the value 254 (asynchronous, manufacturer-specific). In the OPERATIONAL state, the sensor then cyclically transmits the TPDO with the set period duration.

9.6.1.3 Synchronous Transmission

The synchronous transmission is used to get inclination values from more than one sensor at the same time. Therefore, CANopen provides a SYNC object - a CAN message without user data - transmitted with high priority on the bus. This SYNC object is transmitted from a bus node (usually the master) cyclically at

fixed intervals. The sensor reads its current angle value after every " n-th" reception of the SYNC object and sends the TPDO directly afterward as soon as the bus allows this.

Synchronized transmission activates by writing the configuration object for the corresponding TPDO. (Object 1800h to 1803h for TPDO 1 to 4). For this, the sub-index 02h (transmission type) must contain the value $n = 1...240$.

9.6.1.4 Event-controlled transmission on inclination change (manufacturer specific)

The bus load from PDOs can be reduced if the TPDO1 is only transmitted when an appropriate angle change has occurred. This function can only be configured in the manufacturer-specific part of the object directory under index 3001h. To this end, the entry 1800h/02h (transmission type) must contain the value 254 (asynchronous, manufacturer-specific). The event controlled transmission on inclination change can be activated for TPDO1 only.

9.7 Service Data: SDO

The parameters, listed in the object dictionary, are read and written through Service Data Objects (SDOs). As shown in Table 26, every object can directly be addressed over a 16-bit index. In addition, each index has an 8-bit subindex that allows an additional choice within an index. The 8 bytes of the SDOs are placed in the data area of the CAN message.

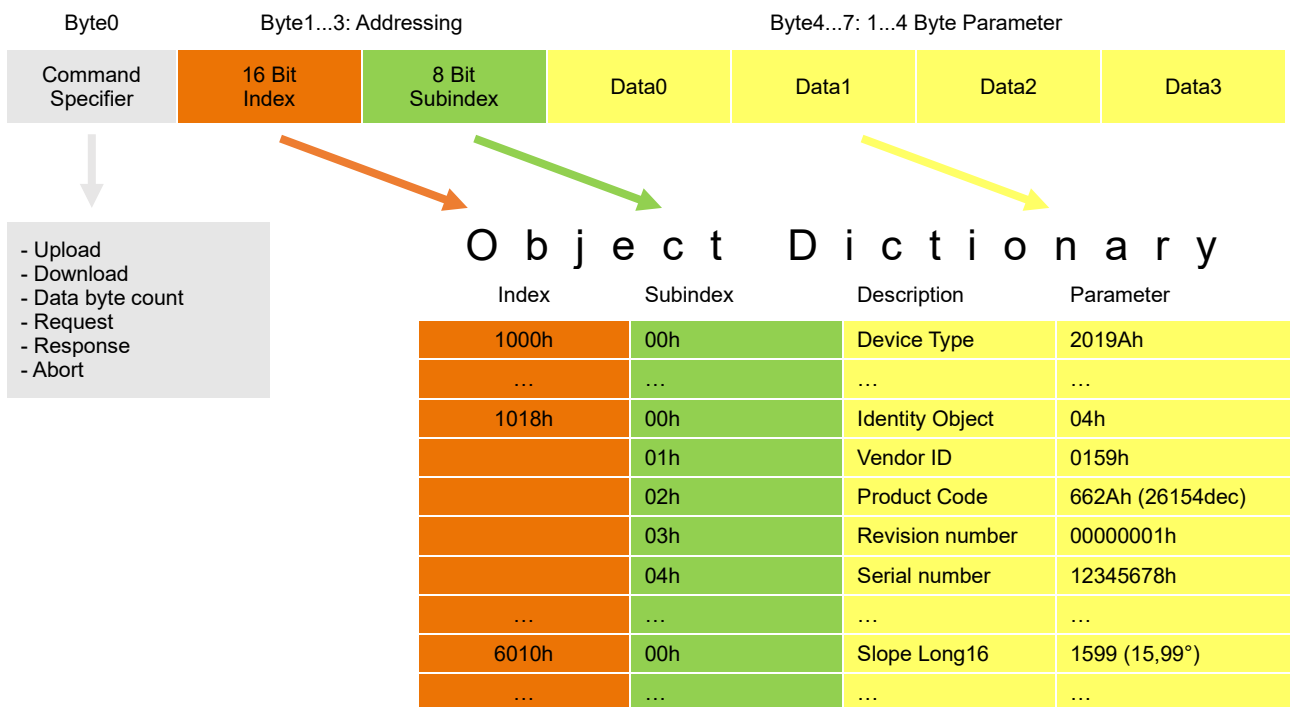

Figure 18: SDO Protocol – Access to Object Dictionary

9.8 Object Dictionary

The object directory contains all data objects that are accessible from the outside and affect the behavior of communication, application and status machines. It is divided into three parts:

- Communication specific Part (Index: 0x1000 – 0x1FFF)
- Manufacturer specific Part (Index: 0x2000 – 0x5FFF)
- Profile specific Part (Index: 0x6000 – 0x9FFF)

All parameters in the object dictionary can be read and written using the standard SDO via index and sub-index.

The following sections describe all the parameters in the object dictionary of the sensor with index, sub-index, data type, access rights and default (factory setting). The column "Save" indicates whether a parameter in the internal volatile memory ("save" signature in OD-Write Index 1010h/01h) can be saved.

9.8.1 Communication Parameters (according to CiA DS-301)

Index	Sub-Index	Parameter	Data Type	Access	Default Value	Save
1000h	0	Device Type (Device profile 410)	UNS32	const	2019Ah	
1001h	0	Error Register	UNS8	ro	0	
1002h	0	Manufacturer Status Register	UNS32	ro	0	
1003h	Pre-defined Error Field					
	0	Number of Errors entries	UNS32	rw	0	
	1..5	Error Code (oldest error on highest index)	UNS32	ro	0	
1005h	0	COB-ID Sync Message	UNS32	rw	80h	
1008h	0	Manufacturer Device Name	VSTR	const	{type dep.}	
100Ah	0	Manufacturer Software Version („Vxx.yy“)	VSTR	const	{type dep.}	
100Ch	0	Guard Time (Multiple of 1 ms)	UNS16	rw	0	x
100Dh	0	Life Time Factor	UNS8	rw	0	x
1010h	Store Parameters (Signature: 's','a','v','e' - 65766173h at SubIndex 1...4)					
	0	Largest supported SubIndex	UNS32	ro	4	
	1	Save all Parameters (OV: 0x1000-0x9FFF)	UNS32	rw	1	
	2	Save Communication Parameters (OV: 0x1000-0x1FFF)	UNS32	rw	1	
	3	Save Application Parameters (OV: 0x6000-0x9FFF)	UNS32	rw	1	
	4	Save Manufacturer Parameters (OV: 0x2000-0x5FFF)	UNS32	rw	1	
1011h	Restore Default Parameters (Signature: 'l','o','a','d' - 64616F6Ch at SubIndex 1...4)					
	0	Largest supported SubIndex	UNS32	ro	4	
	1	Restore all Default Parameters (OV: 0x1000-0x9FFF)	UNS32	rw	1	
	2	Restore Communication Default Parameters (OV: 0x1000-0x1FFF)	UNS32	rw	1	
	3	Restore Application Default Parameters (OV: 0x6000-0x9FFF)	UNS32	rw	1	
	4	Restore Manufacturer Default Parameters (OV: 0x2000-0x5FFF)	UNS32	rw	1	
1014h	0	COB-ID Emergency Message	UNS32	ro	80h + Node-ID	
1015h	0	Inhibit Time Emergency (multiple of 100 µs)	UNS16	rw	0	x
1017h	0	Producer Heartbeat Time (multiple of 1 ms, 0 inactive)	UNS16	rw	0	x
1018h	Identity Object					

Index	Sub-Index	Parameter	Data Type	Access	Default Value	Save
	0	Largest supported SubIndex	UNS8	ro	4	
	1	Vendor-ID (Manufacturer ID: GEMAC Chemnitz GmbH)	UNS32	ro	159h	
	2	Product Code	UNS32	ro	{type dep.}	
	3	Revision number	UNS32	ro	1Eh	
	4	Serial number	UNS32	ro	{type dep.}	
1200h	Server SDO1 Parameter					
	0	Largest supported SubIndex	UNS8	ro	2	
	1	COB-ID Client > Server	UNS32	ro	600h + Node-ID	
	2	COB-ID Server > Client	UNS32	ro	580h + Node-ID	
1800h	Transmit PDO1 Communication Parameter					
	0	Largest supported SubIndex	UNS8	ro	5	
	1	COB-ID	UNS32	ro*	180h + Node-ID	x*
	2	Transmission Type (synchronous / asynchronous manufacturer specific)	UNS8	rw	1	x
	3	Inhibit Time between two TPDO Messages (multiple of 100 µs)	UNS16	rw	0	x
	4	Compatibility Entry	UNS8	rw	0	x
	5	Event Timer (Multiple of 1 ms, 0 inactive)	UNS16	rw	0	x
1801h	Transmit PDO2 Communication Parameter					
	0	Largest supported SubIndex	UNS8	ro	5	
	1	COB-ID	UNS32	ro*	80000280h + Node-ID	x*
	2	Transmission Type (synchronous / asynchronous manufacturer specific)	UNS8	rw	1	x
	3	Inhibit Time between two TPDO Messages (multiple of 100 µs)	UNS16	rw	0	x
	4	Compatibility Entry	UNS8	rw	0	x
	5	Event Timer (Multiple of 1 ms, 0 inactive)	UNS16	rw	0	x
1802h	Transmit PDO3 Communication Parameter					
	0	Largest supported SubIndex	UNS8	ro	5	
	1	COB-ID	UNS32	ro*	80000380h + Node-ID	x*
	2	Transmission Type (synchronous / asynchronous manufacturer specific)	UNS8	rw	1	x
	3	Inhibit Time between two TPDO Messages (multiple of 100 µs)	UNS16	rw	0	x
	4	Compatibility Entry	UNS8	rw	0	x
	5	Interval time for cyclic transmission (multiple of 1 ms, 0 deactivated)	UNS16	rw	0	x
1803h	Transmit PDO4 Communication Parameter					
	0	Largest supported SubIndex	UNS8	ro	5	
	1	COB-ID	UNS32	ro*	80000480h + Node-ID	x*
	2	Transmission Type (synchronous / asynchronous manufacturer specific)	UNS8	rw	1	x
	3	Inhibit Time between two TPDO Messages (multiple of 100 µs)	UNS16	rw	0	x
	4	Compatibility Entry	UNS8	rw	0	x
	5	Interval time for cyclic transmission (multiple of 1 ms, 0 deactivated)	UNS16	rw	0	x
1A00h	Transmit PDO1 Mapping Parameter					
	0	Largest supported SubIndex	UNS8	ro	2	
	1	Mapping Entry 1	UNS32	rw	0x60100010	x

Index	Sub-Index	Parameter	Data Type	Access	Default Value	Save
	2	Mapping Entry 2	UNS32	rw	0x60200010	x
	3	Mapping Entry 3	UNS32	rw	0	x
	4	Mapping Entry 4	UNS32	rw	0	x
	5	Mapping Entry 5	UNS32	rw	0	x
	6	Mapping Entry 6	UNS32	rw	0	x
	7	Mapping Entry 7	UNS32	rw	0	x
	8	Mapping Entry 8	UNS32	rw	0	x
1A01h	Transmit PDO2 Mapping Parameter					
	0	Largest supported SubIndex	UNS8	ro	2	
	1	Mapping Entry 1	UNS32	rw	0x31000110	x
	2	Mapping Entry 2	UNS32	rw	0x31000210	x
	3	Mapping Entry 3	UNS32	rw	0	x
	4	Mapping Entry 4	UNS32	rw	0	x
	5	Mapping Entry 5	UNS32	rw	0	x
	6	Mapping Entry 6	UNS32	rw	0	x
	7	Mapping Entry 7	UNS32	rw	0	x
	8	Mapping Entry 8	UNS32	rw	0	x
1A02h	Transmit PDO3 Mapping Parameter					
	0	Largest supported SubIndex	UNS8	ro	3	
	1	Mapping Entry 1	UNS32	rw	31020110h	x
	2	Mapping Entry 2	UNS32	rw	31020210h	x
	3	Mapping Entry 3	UNS32	rw	31020310h	x
	4	Mapping Entry 4	UNS32	rw	0	x
	5	Mapping Entry 5	UNS32	rw	0	x
	6	Mapping Entry 6	UNS32	rw	0	x
	7	Mapping Entry 7	UNS32	rw	0	x
	8	Mapping Entry 8	UNS32	rw	0	x
1A03h	Transmit PDO4 Mapping Parameter					
	0	Largest supported SubIndex	UNS8	ro	3	
	1	Mapping Entry 1	UNS32	rw	31030110h	x
	2	Mapping Entry 2	UNS32	rw	31030210h	x
	3	Mapping Entry 3	UNS32	rw	31030310h	x
	4	Mapping Entry 4	UNS32	rw	0	x
	5	Mapping Entry 5	UNS32	rw	0	x
	6	Mapping Entry 6	UNS32	rw	0	x
	7	Mapping Entry 7	UNS32	rw	0	x
	8	Mapping Entry 8	UNS32	rw	0	x
1F51h	Download Program Control					
	0	Largest supported SubIndex	UNS8	ro	1	
	1	Area Firmware	UNS8	rw	1	
1F80h	0	Self-Starting Device (bit 3) only writing and deleting of bit 3 (value 8h) allowed	UNS32	rw	0	x

* The valid Bit (Bit 31) of COB-ID is saved

Table 26: Communication Parameters in the Object Dictionary

9.8.1.1 Error Register (1001h)

The error register displays the general error state of the device. Each bit stands for an error group. If one bit is set (= 1), at least one error of that specific group occurred. The content of this register is transmitted in each EMCY object. The following error groups may occur:

Error Register (1001h)							
Bit7	Bit6	Bit5	Bit4	Bit3	Bit2	Bit1	Bit0
Manufacturer Specific Error	Accuracy Warning	Profile Specific Error	Communication Error		unused		At least one active fault

Table 27: Error Register (1001h)

If the device is in error state (at least one active error) this is shown by the set Bit0 (= 1). In case of a communication error (overflow of the transmit / receive buffers, guarding errors or CAN controller in passive mode / Bus-Off) the Bit4 is set. A device profile specific error (sensor error) is shown by Bit5. The Bit7 indicates a vendor-specific error (EEPROM error).

9.8.1.2 Manufacturer Status Register (1002h)

This Register shows the recent state of all detectable errors. Here each bit represents a specific error. If a bit is set (= 1), this error is active at that moment. The lower 16 bits of this register (Bit15...Bit0) are transmitted in the first two bytes of the manufacturer specific part of each EMCY object and are also registered in the additional information field (Bit31-Bit16) of the Pre-defined Error Field 1003h. The definitions of the individual bits in the bit fields "Device Error" and "Communication Error" are shown in Table 39.

Manufacturer Status Register (1002h)		
Bit31...Bit16	Bit15...Bit8	Bit7...Bit0
unused	Bit field Communication Error	Bit field Device Error

Table 28: Manufacturer Status Register (1002h)

9.8.1.3 Pre-defined Error Field (1003h)

Each sensor has an error list holding the last five errors. The entry 1003h/00h contains the number of error entries in the error field. The other subindices contain all occurred error states in chronological order. The last error occurred is always located at SubIndex 01h. The oldest error can be found in the largest available SubIndex (value of 1003h/00h) and will be the first to be deleted from the list with occurrence of more than five errors. If a new error occurs a new error entry is added in 1003h and the master is notified by an EMCY object. An error entry is structured as follows:

Error Entry in Pre-defined Error Field (1003h)	
Additional Information Field (Bit31...Bit16)	Error Code (Bit15...Bit0)
Bit15...Bit0 of the manufacturer status register 1002h (at the moment of error occurrence)	0000h Error reset or no error present 5000h EEPROM error 5010h Sensor Error X

Bit field Communication error	Bit field Device Error	5020h 5040h 8110h 8120h 8130h 8140h	Sensor Error Y Accuracy warning / measuring range exceeded Overflow of the transmit / receive buffers CAN Warning Limit reached Node Guard Event Recovered from Bus-Off
----------------------------------	---------------------------	--	--

Table 29: Error Entry in Pre-defined Error Field (1003h)

The error list can be reset completely by writing “0” to entry 1003h/00h.

9.8.1.4 Saving (1010h) and Loading (1011h) of Parameters

If parameters are changed in the object dictionary those changes will take effect immediately. To ensure the changed parameters are still active after Reset they have to be saved in the internal EEPROM. By writing the signature „save“ (65766173h) to the entry 1010h/01h all the current parameters of the object dictionary will be saved in the internal permanent memory.

The object dictionary can be reset to its default settings by writing the signature „load“ (64616F6Ch) into the entry 1011h/01h. By doing this the factory parameters are written in the permanent memory. After a „Reset Application“ (NMT command) or a hardware reset the changes will take effect (a „Reset Communication“ (NMT command) effects the communication parameters only).

By writing the signature on SubIndex: 02h, 03h or 04h, it is possible to store or load only parts of the object directory.

9.8.1.5 Transmit PDO – Transmission Type (1800h / 1801h / 1802h / 1803h)

The sub-index 02h can be used to define how the sending of the PDO is triggered.

Transmit PDO - Transmission Type	
Transmission Type	Description
1...240	Synchronous (cyclic) Transmission after each 1...240 reception of a SYNC message only „Synchronized Transmission“ via SYNC possible
253	Transmission with RTR only
254	Asynchronous, manufacturer-specific „Cyclic Transmission“ and/or „Transmission on Inclination Change“ (TPDO1 only) activated by appropriate configuration

Table 30: Transmit PDO – Transmission Type

9.8.2 Manufacturer Specific Part

Index	Sub-Index	Parameter	Data type	Access	Default value	Save
2002h	0	Automatic Bus-Off Recovery	BOOL	rw	0	x
3000h	Low pass filter settings					
	0	Largest supported SubIndex	UNS8	ro	2	
	1	Filter type (0=off, 1=Butterworth, 2=critical damped)	UNS16	rw	2	x
	2	Cut-off frequency digital filter (100...25000/8000, in mHz)	UNS16	rw	5000	x
3001h	TPDO1 Transmission on Inclination Change					
	0	Largest supported SubIndex	UNS8	ro	3	
	1	Enable/Disable (1/0) transmission on inclination change	UNS16	rw	0	x

Index	Sub-Index	Parameter	Data type	Access	Default value	Save
	2	min. inclination change for longitudinal (X) axis (in 1/100°)	UNS16	rw	100	x
	3	min. inclination change for lateral (Y) axis (in 1/100°)	UNS16	rw	100	x
3002h	Sensor fusion configuration					
	0	Largest supported SubIndex	UNS8	ro	2	
	1	Enable/Disable (1/0) sensor fusion algorithm	UNS8	rw	1	x
	2	Maximum time of disturbance suppression (in ms)	UNS16	rw	5000	x
	3	Activate/deactivate automatic drift compensation (1/0)	UNS8	rw	1	x
	4	Trigger manual drift compensation (by writing 1)	UNS8	w	0	
	5	Sensitivity for automatic drift compensation	UNS8	rw	3	x
	6	Activate / deactivate adaptive damping (1/0)	UNS8	rw	1	x
	7	Damping factor (valid range: 0 ... 20)	UNS8	rw	19	x
3003h	Configuration of the orientation / measuring axes					
	0	Highest supported subindex	UNS8	ro	3	
	1	Mounting position (see chapter 9.8.2.5)	UNS8	rw	0	x
	2	Swap measuring axes	UNS8	rw	0	x
	3	Carry out automatic determination of the orientation (write 1)	UNS8	wo	-	x
3100h	Euler angle output					
	0	Largest supported SubIndex	UNS8	ro	2	
	1	Euler angle Pitch (in °/100)	INT16	ro	-	
	2	Euler angle Roll (in °/100)	INT16	ro	-	
3101h	Quaternion output					
	0	Largest supported SubIndex	UNS8	ro	4	
	1	Quaternion scalar part w (in 1/30000)	INT16	ro	-	
	2	Quaternion vector part x (in 1/30000)	INT16	ro	-	
	3	Quaternion vector part y (in 1/30000)	INT16	ro	-	
	4	Quaternion vector part z (in 1/30000)	INT16	ro	-	
3102h	Acceleration output					
	0	Largest supported SubIndex	UNS8	ro	3	
	1	Acceleration x axis (in 1/4096 g)	INT16	ro	-	
	2	Acceleration y axis (in 1/4096 g)	INT16	ro	-	
	3	Acceleration z axis (in 1/4096 g)	INT16	ro	-	
	4	Unfiltered acceleration x axis (in 1/4096 g)	INT16	ro	-	
	5	Unfiltered acceleration y axis (in 1/4096 g)	INT16	ro	-	
	6	Unfiltered acceleration z axis (in 1/4096 g)	INT16	ro	-	
3103h	Raw data output angular rate sensor					
	0	Largest supported SubIndex	UNS8	ro	3	
	1	Angular rate x axis (in 7/800 °/s)	INT16	ro	-	
	2	Angular rate y axis (in 7/800 °/s)	INT16	ro	-	
	3	Angular rate z axis (in 7/800 °/s)	INT16	ro	-	
3104h	Gyro angle output					
	0	highest supported subindex	UNS8	ro	3	
	1	Gyro angle x axis (in 1/100°)	INT16	ro	-	
	2	Gyro angle y axis (in 1/100°)	INT16	ro	-	

Index	Sub-Index	Parameter	Data type	Access	Default value	Save
	3	Gyro angle z axis (in 1/100°)	INT16	ro	-	
3105h	Output static angles					
	0	highest supported subindex	UNS8	ro	-	
	1	perpendicular angle: longitudinal (x axis, in 1/100°)	INT16	ro	-	
	2	perpendicular angle: lateral (y axis, in 1/100°)	INT16	ro	-	
	3	Euler angle: Pitch (in 1/100°)	INT16	ro	-	
	4	Euler angle: Roll (in 1/100°)	INT16	ro	-	
4000h	0	Bootloader control	UNS32	w	-	
5555h	Reserved index (access for manufacturer only)					

Table 31: Manufacturer Specific Part of the Object Dictionary

9.8.2.1 Automatic Bus-Off Recovery (2002h)

This property determines the behavior of the sensor when it is in the state Bus-Off. If enabled, the sensor, which is in Bus-Off state may become error-active (no longer Bus-Off) with its error counters both set to zero after having monitored 128 occurrences of 11 consecutive recessive bits on the bus.

If disabled, the sensor remains in Bus-Off state.

9.8.2.2 Low Pass Filter Settings (3000h)

Through the entry 3000h/01h the filter type will be selected. The cut-off frequency is programmable through the object 3000h/02. Values for the cut-off frequency are allowed between 100 (= 0.1 Hz) and 25000/8000 (= 25 Hz/8 Hz). A description of the digital filter can be found in section 7.1 „Low pass filter“.

Filter	Filter type (3000h/01h)	Adjustable frequency range (3000h/02h)	Applications
deactivated	0	-	static inclination measurement for applications without external forces
Butterworth	1	0.1 Hz ... 25 Hz	Static inclination measurement with high damping to vibration
Critically damped	2	0.1 Hz ... 8 Hz	Inclination measurement in applications that requires a certain dynamism, without overshoot at angle changes with good damping

Table 32: Filter selection

9.8.2.3 TPDO1 Transmission on Inclination Change (3001h)

Through the entry 3001h/01h the event controlled transmission of the TPDO1 on inclination change can be enabled (= 1) or disabled (= 0). For the activation the transmission type of TPDO1 must be set to “Asynchronous, manufacturer-specific” (1800h/02h = 254).

subIndices 02h and 03h offer the separated setting of the minimum necessary inclination change for the longitudinal (X) and lateral (Y) axis.

The angle values are mentioned in °/100 (100fold angle value) and can be set freely from 1 = 0.01° to maximum.

If this function is enabled the sensor outputs the TPDO1 object in the state OPERATIONAL in case of inclination changes of the longitudinal and/or the lateral axis greater than set under 3001h/02h and 03h. During operation the angle difference between the recent inclination value and the last one sent by the TPDO1 is permanently calculated and checked. With each change to the state OPERATIONAL the sensor posts the recent position by the TPDO1 object, too (only if 3001h/01h = 1).

Remarks:

If small inclination differences are set under 3001h/02h and 03h it is recommended to enable the low pass filter (index 3000h) and the sensor fusion filter (index 3002h) to reduce the influence of vibrations and the frequent output of the TPDO1.

9.8.2.4 Configuration of the sensor fusion (3002h)

The sub-indices of the object 3002h are available for the configuration of the sensor fusion filter (see chapter 7.2 „Sensor fusion filter“). Sub-index 01h enables the activation and deactivation of the sensor fusion. The interference suppression time is configured under 3002h / 02h. Sub-index 03h to 05h configure the drift compensation for the gyro data. For the extended configuration, there are sub-index 06h for activating or de-activating the adaptive damping and sub-index 07h for setting the damping factor (see Table 6).

9.8.2.5 Configuration of the mounting position / measuring axes (3003h)

The mounting position of the sensor or the orientation of the measuring axes (see Chapter 4 “Mounting position / orientation of the measuring axes”) can be set using 3003h / 01h. The possible values and the associated orientation are shown in Table 33.

Sub-index 02h configures the exchange of the measuring axes (0: no exchange, 1: exchange). The automatic determination of the sensor orientation can be carried out by writing 1 to 3003h / 03h. The sensor should stand still when this command is written. The automatic orientation may have an effect on the angle output of the sensor and determines one of the 6 in Chapter 4 “Mounting position / orientation of the measuring axes” / in Table 33 listed orientations.

Value 3003h/01h	Orientation
0 (default)	z-up
1	z-down
2	y-up
3	y-down
4	x-up
5	x-down

Table 33: Values for the sensor orientation

9.8.3 Device Profile Specific Part (according to CiA DS-410)

Index	Sub-Index	Parameter	Data type	Access	Default value	Save
6000h	0	Resolution (multiple of 0.001°)	UNS16	ro	10	
6010h	0	Inclination value longitudinal (X-axis, 100fold angle value in °)	INT16	ro	-	
6011h	0	Operating Parameter longitudinal (Inversion, Zero Point Adjustment)	UNS8	rw	0	x
6012h	0	Preset Value longitudinal x axis	INT16	rw	0	x
6013h	0	Offsetwert für longitudinale (X) Achse	INT16	rw	0	x
6014h	0	Differential Offset Value longitudinal x axis	INT16	rw	0	x
6020h	0	Inclination value lateral (y axis, 100fold angle value in °)	INT16	ro	-	
6021h	0	Operating Parameter lateral (Inversion, Zero Point Adjustment)	UNS8	rw	0	x
6022h	0	Preset Value lateral y axis	INT16	rw	0	x
6023h	0	Offset Value lateral y axis	INT16	rw	0	x
6024h	0	Differential Offset Value lateral y axis	INT16	rw	0	x
6511h	0	Temperature (internal in °C)	INT8	ro	-	

Table 34: Device Profile Specific Part of the Object Dictionary

9.8.3.1 Resolution (6000h)

The resolution of the sensor is constantly set to 0.01° (default: 10 * 0.001°). All angle values in the object dictionary (6010h, 6012h, 6013h, 6014h and 6020h, 6022h, 6023h, 6024h) are to be interpreted as a multiple of 0.01°.

Example:

Inclination value = $-2370 \times 0.01^\circ = -23.70^\circ$

9.8.3.2 Inclination values axial (610h) / Inclination values longitudinal and lateral (6010h and 6020h)

The recent inclination values of the inclination axis are accessible by SDO access to the object dictionary (in each device state) as well as by TPDO. If Zero Point Adjustment is enabled via the operating parameters 6011h and 6021h, the inclination value is calculated as follows:

$$\text{Inclination Value} = \text{Physically Measured Inclination Value} + \text{Diff. Offset Value} + \text{Offset Value}$$

On disabled Zero Point Adjustment:

$$\text{Inclination Value} = \text{Physically Measured Inclination Value}$$

Example:

Value Range: $-9000 \dots +9000 \rightarrow -90.00^\circ \dots +90.00^\circ$

9.8.3.3 Operating Parameters (6011h and 6021h)

The operating parameters settings of a sensor (6011h and 6021h) allow the changing of the mathematical sign of the inclination value and a Zero Point Adjustment. On Factory Default Settings, these options are disabled, i.e. the direction of the inclination value (polarity of the axis) corresponds to the one shown on the nameplate of the sensor (see Figure 1).

Operating Parameters (6011h and 6021h)							
Bit7	Bit6	Bit5	Bit4	Bit3	Bit2	Bit1	Bit0
unused						Zero Point Adjustment 0 = inactive 1 = active	Inversion 0 = inactive 1 = active

Table 35: Operating Parameters (6011h and 6021h)

The inversion of the inclination values affects the sign of the output of the perpendicular angle and the Euler angle. All other output data are not affected.

9.8.3.4 Zero Point Adjustment for perpendicular angles: Preset Value, Offset Value, Differential Offset Value (60x1/2/3h)

Using the values “Preset Value”, “Offset Value” and “Differential Offset Value” the adjustment of the Zero Point of inclination value (perpendicular angle) is possible. The Zero Point Adjustment is only active if the Bit1 in the operating parameters (6011h/6021h) is set.

The zero point setting does not affect the output of the Euler angles.

Value	Object	Description
Preset Value	6012h 6022h	Preset Value for Zero Point Adjustment, value range depends on settings in object 6000h
Offset Value	6013h 6023h	Calculated Offset Value when writing to object 6012h or 6021h Calculated Offset Value = Preset Value at tacc – physically measured Inclination Value at tacc – Differential Offset Value tacc: time when accessing object (6012h, 6022h)
Differential Offset Value	6014h 6024h	Additional Offset, regardless of object 6012h and 6013h / 6022h and 6023h. The value you enter here will be added up directly to the inclination value.

Table 36: Zero Point Adjustment

9.9 Emergency Objects

Each inclination sensor supports EMCY objects which are transmitted in case of sensor and hardware errors. If such an error occurs the OD entries 1001h (Error Register), 1002h (Manufacturer Status Register) and 1003h (Pre-defined Error Field) are updated. After abolishment of an error, the device transmits an emergency message with the Error Reset Code 0x0000. Remaining errors are signaled in Byte2 (Error Register) and Bytes 3 and 4 in the Manufacturer specific error field. Once the device is error-free, it sends an emergency message which contains only zeros. The current state of the device (Pre-Operational, Operational or Stopped) is not influenced by the error states, except in case of a guarding error.

Emergency messages are sent with high priority on the bus and are always 8 bytes long. The structure of the telegram is shown in Table 37:

Emergency Object							
Byte0	Byte1	Byte2	Byte3	Byte4	Byte5	Byte6	Byte7
Emergency Error Code		Error Register (1001h)	Manufacturer Specific Error Field				
			Bit field Communication Error	Bit field Device Error	0x00	0x00	0x00

Table 37: Emergency Object

Emergency Error Codes	
0x0000	Error Reset or no Error (Error Register = 0)
0x5000	EEPROM error, error when saving the configuration
0x5010	Sensor Error x axis
0x5020	Sensor Error y axis
0x5040	Accuracy warning, acceleration or angular rate values are out of range, inclination accuracy of the sensor is limited
0x8110	Overflow of the transmit / receive buffers, CAN messages were lost
0x8120	CAN Warning Limit reached
0x8130	Node Guard Event (The loss of the Guarding-Master has been detected)
0x8140	Recovered from Bus-Off

Table 38: Emergency Error Codes

Bit field Device Errors	
0x01	Sensor Error x axis
0x02	Sensor Error y axis
0x80	EEPROM Error: An error occurred while saving the configuration.
Bit field Communication Errors	
0x01	CAN Warning Limit reached (too many Error Frames)
0x02	CAN Bus-Off State reached. An Emergency message will be transmitted after the device has recovered from Bus-Off.
0x04	Receive Queue Overrun, CAN messages were lost
0x08	Transmit Queue Overrun, CAN messages were lost
0x80	Guarding Error, The loss of the Guarding-Master has been detected (Node Guard Event)

Table 39: Emergency: Manufacturer Specific Error Field

9.10 Failure monitoring

Since the nodes do not respond at regular intervals with the event-controlled transmission in a CANopen network, Heartbeat and Nodeguarding / Lifeguarding failure monitoring mechanisms are provided. Only one of the two monitoring methods can be active.

9.10.1 Nodeguarding / Lifeguarding

Nodeguarding is the monitoring of one or several nodes by the NMT master. The NMT master periodically sends a RTR message frame to the slave to be monitored, which responds with its status and a toggle bit. If the status or the toggle bit do not comply with the status or toggle bit expected by the guarding master or if no response is provided, the master assumes a slave error.

The node to be monitored may also use this mechanism to detect a failure of the guarding master. Therefore two parameters are used. The interval time after which the guarding master polls the sensor to be monitored is the Guard Time (100Ch). Another parameter, the Life Time Factor (100Dh), defines a multiplier after which the connection is deemed to be interrupted. This time is designated as the node life time.

$$\text{„Node Life Time“} = \text{„Guard Time“} \times \text{„Life Time Factor“}$$

If the sensor does not receive a guarding request from the master within the parametrized time, it also assumes a master failure, sends an emergency message frame and returns to the "Pre-Operational" state. If either of the two parameters is "0" (default setting), the master is not monitored (no Lifeguarding).

9.10.2 Heartbeat

Heartbeat is a failure monitoring mechanism which can operate without using RTR message frames. In this case, the sensor cyclically transmits a heartbeat message which contains the state of the device. The master can monitor these message frames. Heartbeat is activated once a value greater than "0" is entered in the heartbeat interval time register (1017h).

Remarks:

Heartbeat has a significant influence on the bus load of the CANopen network, but produces only half the bus load of Nodeguarding / Lifeguarding.

9.11 LSS: Layer Setting Service (according to CiA DSP-305)

9.11.1 Setting of Node-ID and Baud Rate

The setting of the node address (Node-ID) and the Baud Rate is realized by LSS (Layer Setting Service). For communication between LSS Master and LSS Slave (sensor) two CAN identifiers (7E5h and 7E4h) are used. Each sensor has a unique 128-bit LSS address, at which it can be addressed in the CAN network. This address is composed of the three 32-bit parameters of the Identity object 1018h and the serial number:

Vendor-ID	0000 0159h	(Manufacturer ID: GEMAC Chemnitz GmbH)
Product Code	0000 6A0Ah	(6A0Ah = 27146dec = PR- 27146-30)
Revision Number	0000 001Eh	(1Eh = 30dec = PR- 27146-30)
Serial Number	xxxx xxxh	(serial number of the sensor → nameplate)

The default values for Node-ID and Baud Rate at delivery (factory settings) are:

Node-ID	10
Baud Rate	Automatic Baud Rate Detection

Index	Baud Rate
0	1 MBit/s
1	800 kBit/s
2	500 kBit/s
3	250 kBit/s
4	125 kBit/s

Index	Baud Rate
5	unbenutzt
6	50 kBit/s
7	20 kBit/s
8	10 kBit/s
9	Automatic Baud Rate Detection

Table 40: LSS Baud Rate Index according to CiA DSP-305

9.12 Automatic Baud Rate Detection (according to CiA AN-801)









The automatic baud rate detection is used to automatically adjust the baud rate of the sensor on the existing baud rate in the network. For this purpose, after switching on the power supply, the sensor is in the so-called "Listen-Only" mode, in which it observes the telegrams on the CAN bus, but does not give any acknowledge itself. This operating condition is characterized by the flickering RUN-LED (see also section 9.13 "Status LED (according to CiA DR-303-3)"). The sensor checks all the available baud rates. Upon reception of a valid CAN telegram, the correct baud rate is adjusted. Then the sensor starts up, sends its boot-up message and enters the Pre-Operational state. (see also Figure 17).

Remarks:

For proper operation of the automatic baud rate detection it is necessary to receive messages from other can nodes on the bus.

9.13 Status LED (according to CiA DR-303-3)

The integrated two-color Status LED signals the recent device state (Run LED, green) as well as CAN communication errors that might have occurred (Error LED, red). The color and the flashing frequency of the LED distinguish the different device states as shown in Table 41.

Status-LED		
RUN LED	LED State	Description
 ...	Off	The device is in state Reset or no power supply is connected
 ...	Flickering	Automatic baud rate detection is currently running (active)
 ...	Blinking	The device is in state Pre-Operational
 ...	Single Flash	The device is in state Stopped
 ...	On	The device is in state Operational
ERROR LED		
ERROR LED	LED State	Description
 ...	Off	The device is in working condition
 ...	Single Flash	CAN Warning Limit reached or exceeded
 ...	Double Flash	The loss of the Guarding-Master has been detected (Node Guard Event)
 ...	On	The device is in state "Bus-Off"





Legend:  LED off  LED on  LED flickering (50 ms an/aus) Duration of one state ( / ): 200 ms

Table 41: Status and Error Display of the Status LED

10 Functional Description SAE J1939 Interface

10.1 Message format

SAE J1939 uses extended identifiers (29 bit) for CAN-bus communication. A general distinction can be made between telegrams that are exchanged between two participants with direct addressing (PDU format 1) and Broadcast messages that are sent to all participants on the bus (PDU format 2).

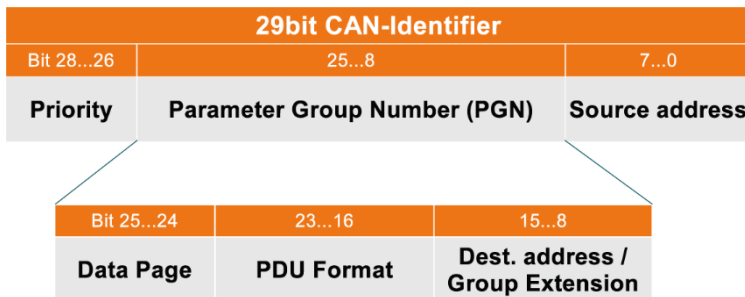

Figure 19: SAE J1939 CAN-Identifier

Point-to-point messages are sent with a PDU format value of 00h to EFh and a specific destination address. Broadcast messages contain the PDU format values F0h to FFh. The field group extension increases the number of available broadcast messages.

The sensor supports broadcast messaging with PDU format 2 for sending process data (like angle values or raw sensor data, see section 10.3 “Process data (Transmit PGNs)”). For configuration of the sensor, direct addressing with PDU format 1 and proprietary A PGN is used (see section 10.5 „Sensor configuration“).

10.2 Device name and address

With factory default setting, the sensor starts with a device address of 128 (80h). Dynamic addressing is supported. After power-on, the sensor transmits an address-claim message containing the used address and the 64 bit device name, which identifies the sensor uniquely on the bus. The device name also defines the priority of the sensor in the network.

The 64 bit device name contains the following fields:

- Arbitrary Address Capable, support of dynamic addressing (1 bit)
- Industry Group (3 bit)
- Vehicle System Instance (4 bit)
- Vehicle System (7 bit)
- Function (8 bit)
- Function Instance (5 bit)
- ECU Instance (3 bit)
- Manufacturer Code (11 bit)
- Identity Number (21 bit)

The Manufacturer Code is the identifier of GEMAC Chemnitz GmbH (value 854 decimal). The Identity Number is the SAE J1939 serial number of the sensor.

The following fields are set to fixed factory settings:

- Manufacturer Code: 854 (GEMAC Chemnitz GmbH)
- Identity Number: SAE J1939 unique serial number of the sensor
- Industry Group: 0
- Vehicle System: 0
- Function: 145 (Inertial Sensor)

All other fields of the device name can be changed by the user by configuration messages (see section 10.5 „Sensor configuration“).

10.3 Process data (Transmit PGNs)

For sending of measurement values, the sensor supports the standardized PGNs 61459 (Slope Sensor Information) and 61481 (Slope Sensor Information 2) as well as PGN 61482 (Angular Rate Information) and PGN 61485 (Acceleration Sensor). Additionally, Proprietary B messages (broadcast) are supported.

The device supports different parameter groups (TxPGNs):

- TxPGN1 61459 Slope Sensor Information
- TxPGN2 61481 Slope Sensor Information 2 (extended range)
- TxPGN3 61482 Angular Rate Information
- TxPGN4 61485 Acceleration Sensor
- Proprietary B TxPGN5 65280 perpendicular angle longitudinal (x-axis) and lateral (y-axis)
- Proprietary B TxPGN6 65281 Euler angles pitch and roll
- Proprietary B TxPGN7 65282 Quaternion
- Proprietary B TxPGN8 65283 acceleration x, y, z
- Proprietary B TxPGN9 65284 angular rate x, y, z
- Proprietary B TxPGN10 65285 Acceleration unfiltered x, y, z
- Proprietary B TxPGN11 65286 Gyro angle x, y, z

The activation/deactivation of transmission, the cycle time, and the priority of the messages, as well as the LSB of the PG number for the Proprietary B PGNs, can be set via configuration messages. By default, TxPGN5 (perpendicular angle) is activated with a cycle time of 10 ms.

The content of the Proprietary B PGNs can be adapted by the user by mapping the signals. The following tables show the standard assignments:

PGN	Name	SPN name	SPN position (bit)	SPN size (bit)	Resolution	Offset	Data range
61459	Slope Sensor Information	Pitch angle	0	16	0.002°/bit	-64°	-64...64.51°
		Roll angle	16	16	0.002°/bit	-64°	-64...64.51°
		Pitch rate	32	16	0.002°/s/bit	-64°/s	-64...64.51°/s

PGN	Name	SPN name	SPN position (bit)	SPN size (bit)	Resolution	Offset	Data range
		Pitch angle Figure of Merit	48	2	4 States	0	0...3
		Roll angle Figure of Merit	50	2	4 States	0	0...3
		Pitch rate Figure of Merit	52	2	4 States	0	0...3
		Sensor fusion status	54	2	4 States	0	0...3
		Latency	56	8	0.5 ms/bit	0	0...125 ms

Table 42: Transmit PGN 1 - 61459 Slope Sensor Information

Latency describes only the internal latency of the sensor and is defined as the time between data acquisition in the sensor and output to the CAN interface. No account is taken of additional latencies caused by the CAN bus and the general system implementation.

PGN	Name	SPN name	SPN position (bit)	SPN size (bit)	Resolution	Offset	Data range
61481	Slope Sensor Information 2	Pitch angle (ext. Range)	0	24	1/32768°/bit	-250°	-250...252° (-90...90°)
		Roll angle (ext. Range)	24	24	1/32768°/bit	-250°	-250...252°
		Pitch angle sensor fusion	48	2	4 States	0	0...3
		Pitch angle Figure of Merit	50	2	4 States	0	0...3
		Roll angle sensor fusion	52	2	4 States	0	0...3
		Roll angle Figure of Merit	54	2	4 States	0	0...3
		Latency	56	8	0.5 ms/bit	0	0...125 ms

Table 43: Transmit PGN 2 - 61481 Slope Sensor Information 2

PGN	Name	SPN name	SPN position (bit)	SPN size (bit)	Resolution	Offset	Data range
61482	Angular Rate Information	Pitch angle (ext. Range)	0	16	1/128°/s/bit	1/128°/s/bit	1/128°/s/bit
		Roll angle (ext. Range)	16	16	-250°/s	-250°/s	-250°/s
		Yaw Rate (ext. Range)	32	16	-250...250°/s	-250...250°/s	-250...250°/s
		Pitch angle Figure of Merit	48	2			
		Roll angle sensor fusion	50	2	1/128°/s/bit	1/128°/s/bit	1/128°/s/bit
		Yaw Rate Figure of Merit	52	2	-250°/s	-250°/s	-250°/s
		Latency	56	8	-250...250°/s	-250...250°/s	-250...250°/s

Table 44: Transmit PGN 3 - 61482 Angular Rate Information

PGN	Name	SPN name	SPN position (bit)	SPN size (bit)	Resolution	Offset	Data range
61485	Acceleration Sensor	Lateral Acceleration (y axis)	0	16	0.01 m/s²/bit	-320m/s²	-80...80m/s²
		Longitudinal Acceleration (x axis)	16	16	0.01 m/s²/bit	-320m/s²	-80...80m/s²
		Vertical Acceleration (z axis)	32	16	0.01 m/s²/bit	-320m/s²	-80...80m/s²
		Lateral Acceleration Figure of Merit	48	2	4 States	0	0...3

PGN	Name	SPN name	SPN position (bit)	SPN size (bit)	Resolution	Offset	Data range
		Longitudinal Acceleration Figure of Merit	50	2	4 States	0	0...3
		Vertical Acceleration Figure of Merit	52	2	4 States	0	0...3
		Support variable transmission repetition rate	54	2	4 States	0	0...3

Table 45: Transmit PGN 4 - 61485 Acceleration Sensor

PGN	Name	SPN name	SPN No.	SPN position (bit)	SPN size (bit)	Resolution	Offset	Data range
65280	Proprietary B TxPGN5 perpendicular angle	Inclination angle longitudinal (x axis)	1	0	16	0.01°/bit	0°	-90...90°
		Inclination angle lateral (y axis)	2	16	16	0.01°/bit	0°	-90...90°
		Static inclination value longitudinal (x axis)	22	32	16	0.01°/bit	0°	-90...90°
		Static inclination value lateral (y axis)	23	48	16	0.01°/bit	0°	-90...90°

Table 46: Transmit PGN 5 – perpendicular angle

PGN	Name	SPN name	SPN No.	SPN position (bit)	SPN size (bit)	Resolution	Offset	Data range
65281	Proprietary B TxPGN6 Euler angles	Euler angle Pitch	3	0	16	0.01°/bit	0°	-90...90°
		Euler angle Roll	4	16	16	0.01°/bit	0°	-180...180°
		Static Euler angle Pitch	24	32	16	0.01°/bit	0°	-90...90°
		Static Euler angle Roll	25	48	16	0.01°/bit	0°	-180...180°

Table 47: Transmit PGN 6 - Euler angles

PGN	Name	SPN name	SPN No.	SPN position (bit)	SPN size (bit)	Resolution	Offset	Data range
65282	Proprietary B TxPGN7 Quaternion	Quaternion scalar part w	6	0	16	1/32768 / bit	0	-1.0...1.0
		Quaternion vector part x	7	16	16	1/32768 / bit	0	-1.0...1.0
		Quaternion vector part y	8	32	16	1/32768 / bit	0	-1.0...1.0
		Quaternion vector part z	9	48	16	1/32768 / bit	0	-1.0...1.0

Table 48: Transmit PGN 7 - Quaternion

PGN	Name	SPN name	SPN No.	SPN position (bit)	SPN size (bit)	Resolution	Offset	Data range
65283	Proprietary B TxPGN8 Acceleration sensor raw data	Acceleration x axis	10	0	16	1/4096g / bit	0	-8g...8g
		Acceleration y axis	11	16	16	1/4096g / bit	0	-8g...8g
		Acceleration z axis	12	32	16	1/4096g / bit	0	-8g...8g

Table 49: Transmit PGN 8 - Acceleration

PGN	Name	SPN name	SPN No.	SPN position (bit)	SPN size (bit)	Resolution	Offset	Data range
65284	Proprietary B TxPGN9 Gyroscope sensor raw data	Angular rate x axis	16	0	16	7/800°/s / bit	0	-250...250°/s
		Angular rate y axis	17	16	16	7/800°/s / bit	0	-250...250°/s
		Angular rate z axis	18	32	16	7/800°/s / bit	0	-250...250°/s

Table 50: Transmit PGN 9 - Angular rate

PGN	Name	SPN name	SPN No.	SPN position (bit)	SPN size (bit)	Resolution	Offset	Data range
65285	Proprietary B TxPGN10 unfiltered acceleration	Acceleration x axis unfiltered	13	0	16	1/4096g / bit	0	-8g...8g
		Acceleration y axis unfiltered	14	16	16	1/4096g / bit	0	-8g...8g
		Acceleration z axis unfiltered	15	32	16	1/4096g / bit	0	-8g...8g

Table 51: Transmit PGN 10 - unfiltered acceleration

PGN	Name	SPN name	SPN No.	SPN position (bit)	SPN size (bit)	Resolution	Offset	Data range
65286	Proprietary B TxPGN11 Gyro angle	Gyro angle x axis	19	0	16	0.01° / bit	0°	-180°...180°
		Gyro angle y axis	20	16	16	0.01° / bit	0°	-180°...180°
		Gyro angle z axis	21	32	16	0.01° / bit	0°	-180°...180°

Table 52: Transmit PGN 11 - Gyro angle

The meaning of the status bits of the output values described in the PGNs is explained in Table 53.

Condition of the status bits	Meaning
00	The described datum is valid and within the specification of the sensor.
01	The forces acting on the sensor are outside of the specification. The datum described is invalid.
10	Error
11	Not available

Table 53: Status Bits in the PGN

10.4 PGN Mapping

The content of the proprietary B PGNs can be adapted by mapping. For this purpose, an SPN (1 byte) is as-signed to each signal that can be output. Up to 4 signals can be mapped per PGN. The signals available for mapping are listed in Table 54. The configuration is carried out using the corresponding telegrams listed in chapter 10.5 „Sensor configuration“.

SPN	Name	Data Type	Resolution	Data Range
0	Not used	-	-	0
1	Perpendicular angle X	16bit signed	0.01 deg/bit	-90.00° ... 90.00°
2	Perpendicular angle Y	16bit signed	0.01 deg/bit	-90.00° ... 90.00°
3	Euler angle: Pitch	16bit signed	0.01 deg/bit	-90.00° ... 90.00°
4	Euler angle: Roll	16bit signed	0.01 deg/bit	-180.00° ... 180.00°
6	Quaternion: w	16bit signed	1/30000 /bit	-1 ... +1
7	Quaternion: x	16bit signed	1/30000 /bit	-1 ... +1
8	Quaternion: y	16bit signed	1/30000 /bit	-1 ... +1
9	Quaternion: z	16bit signed	1/30000 /bit	-1 ... +1
10	Acceleration: x	16bit signed	1/4096 g/bit	-8g ... 8g
11	Acceleration: y	16bit signed	1/4096 g/bit	-8g ... 8g
12	Acceleration: z	16bit signed	1/4096 g/bit	-8g ... 8g
13	Acceleration unfiltered: x	16bit signed	1/4096 g/bit	-8g ... 8g
14	Acceleration unfiltered: y	16bit signed	1/4096 g/bit	-8g ... 8g
15	Acceleration unfiltered: z	16bit signed	1/4096 g/bit	-8g ... 8g
16	Angular Rate: x	16bit signed	7/800 deg/s/bit	-250°/s ... 250°/s
17	Angular Rate: y	16bit signed	7/800 deg/s/bit	-250°/s ... 250°/s
18	Angular Rate: z	16bit signed	7/800 deg/s/bit	-250°/s ... 250°/s
19	Gyro angle: x	16bit signed	0.01 deg/bit	-180.00° ... 180.00°
20	Gyro angle: y	16bit signed	0.01 deg/bit	-180.00° ... 180.00°
21	Gyro angle: z	16bit signed	0.01 deg/bit	-180.00° ... 180.00°
22	Perpendicular angle X (Z) static	16bit signed	0.01 deg/bit	-90.00° ... 90.00°
23	Perpendicular angle Y static	16bit signed	0.01 deg/bit	-90.00° ... 90.00°
24	Euler angle Pitch static	16bit signed	0.01 deg/bit	-90.00° ... 90.00°
25	Euler angle Roll static	16bit signed	0.01 deg/bit	-180.00° ... 180.00°
26	Temperature	16bit signed	0.1 K/bit	-40.0 °C ... 100.0 °C

Table 54: SAE J1939 proprietary B mapping signals

10.5 Sensor configuration

For reading and writing the sensor configuration, proprietary A PGN 61184 (point-to-point messaging) is used. The data part of the telegram has the following structure:

D0	D1	D2	D3	D4	D5	D6	D7
INDEX		CMD	STATUS	DATA0	DATA1	DATA2	DATA3

- INDEX Parameter index (see Table 55)
- CMD Command (0x01: read, 0x02: write)
- STATUS Status (only valid in reply from sensor, see Table 58)
- DATA0...DATA3 0 to 4 bytes of data (valid number of bytes depends on the parameter index)

Index	Parameter	Data Type	Value	Access
0x1000	Vendor-ID	UNS32	-	ro
0x1001	Product-ID	UNS32	-	ro
0x1002	Product revision	UNS32	-	ro
0x1003	Serial number	UNS32	-	ro
0x1004	Firmware version	UNS16	-	ro
0x1005	Device-ID	UNS32	-	
0x1100	Device status	UNS8	-	ro
0x2000	CAN baudrate	UNS16	0: Autobaud 250 (default) 10, 20, 50, 100, 125, 500, 800, 1000	rw
0x2001	Device address	UNS8	128 (default)	rw
0x2002	Automatic Bus-Off Recovery	UNS8	0: (default) inactive 1: active	rw
0x2010	Arbitrary Address Capable	UNS8	0: address claiming inactive 1: address claiming active (default)	rw
0x2011	Industry Group	UNS8	0	ro
0x2012	Vehicle system instance	UNS8	0...15 (default: 0)	rw
0x2013	Vehicle system	UNS8	0	ro
0x2014	Function	UNS8	145	ro
0x2015	Function Instance	UNS8	0...31 (default: 0)	rw
0x2016	ECU Instance	UNS8	0...7 (default: 0)	rw
0x2100	Filter type low pass filter	UNS16	0: inactive 1: Butterworth filter 2: critical damped (default)	rw
0x2101	Cut-Off-frequency low pass filter	UNS16	100...25000 mHz default: 5000 mHz	rw
0x2110	Sensor fusion enable	UNS8	0: Sensor fusion deactivated 1: Sensor fusion activated (default)	rw
0x2111	Sensor fusion suppression time	UNS16	100...10000 ms default: 5000 ms	rw
0x2120	Dynamic gyroscope offset correction	UNS8	0: inactive 1: active (default)	rw
0x2200	Zero offset x axis automatically	UNS8	Set x axis angle to zero 0: reset offset (absolute measurement) 1: zero (relative measurement)	wo
0x2201	Zero offset x axis	INT16	Zero offset x axis	rw
0x2202	Invert x axis	UNS8	0: x axis not inverted 1: x axis inverted	rw
0x2210	Zero offset y axis automatically	UNS8	Set y axis angle to zero 0: reset offset (absolute measurement) 1: zero (relative measurement)	wo
0x2211	Zero offset y axis	INT16	Zero offset y axis	rw
0x2212	Invert y axis	UNS8	0: y axis not inverted 1: y axis inverted	rw
0x2220	Gyro angle x axis read/write	INT16	-18000...17999 equals -180.00 to 179.99°	rw
0x2221	Gyro angle y axis read/write	INT16	-18000...17999 equals -180.00 to 179.99°	rw
0x2222	Gyro angle z axis read/write	INT16	-18000...17999 equals -180.00 to 179.99°	rw
0x2223	Reset gyro angle	UNS8	Writing any value sets the gyro angle of all 3 axes to zero	wo

Index	Parameter	Data Type	Value	Access
0x2300	Store parameters	VSTR	Write 'SAVE' (45564153h) to store parameters permanently	wo
0x2301	Load parameters	VSTR	Write 'LOAD' (44414F4Ch) to load parameters from permanent memory	wo
0x2302	Reset to factory default parameters	VSTR	Write 'CLR' (524C43h) to apply factory default settings	wo
0x2303	Reset sensor	VSTR	Write 'RST' (545352h) to reset the device	wo
Configuration TxPGNs				
0x3000	TxPGN1 cycle time PGN 61459 Slope Sensor Information	UNS16	0: deactivated (default) 10...10000 ms cycle time	rw
0x3001	TxPGN1 priority PGN 61459 Slope Sensor Information	UNS8	0...7 (default: 3)	rw
0x3010	TxPGN2 cycle time PGN 61481 Slope Sensor Information 2	UNS16	0: deactivated 10...10000 ms cycle time default: 10 ms	rw
0x3011	TxPGN2 priority PGN 61481 Slope Sensor Information 2	UNS8	0...7 (default: 3)	rw
0x3020	TxPGN3 cycle time PGN 61482 Angular Rate Information	UNS16	0: deactivated (default) 10...10000 ms cycle time	rw
0x3021	TxPGN3 priority PGN 61482 Angular Rate Information	UNS8	0...7 (default: 3)	rw
0x3030	TxPGN4 cycle time PGN 61485 Acceleration Sensor	UNS16	0: deactivated (default) 10...10000 ms cycle time	rw
0x3031	TxPGN4 priority PGN 61485 Acceleration Sensor	UNS8	0...7 (default: 3)	rw
0x3040	TxPGN5 cycle time PGN 65280 (default: Perpendicular Angle)	UNS16	0: deactivated 10...10000 ms cycle time default: 10 ms	rw
0x3041	TxPGN5 priority PGN 65280 (default: Perpendicular Angle)	UNS8	0...7 (default: 3)	rw
0x3042	TxPGN5 LSB PGN 65280 (default: Perpendicular Angle)	UNS8	0x00...0xFF default: 0x00	rw
0x3048	TxPGN5 Mapping PGN 65280	UNS32	0...26 per byte (default: 0x17160201)	rw
0x3050	TxPGN6 cycle time PGN 65281 (default: Euler-Angle)	UNS16	0: deactivated (default) 10...10000 ms cycle time	rw
0x3051	TxPGN6 priority PGN 65281 (default: Euler-Angle)	UNS8	0...7 (default: 3)	rw
0x3052	TxPGN6 LSB PGN 65281 (default: Euler-Angle)	UNS8	0x00...0xFF default: 0x01	rw
0x3058	TxPGN6 Mapping PGN 65281	UNS32	0...26 per Byte (default: 0x19180403)	rw

Index	Parameter	Data Type	Value	Access
0x3060	TxPGN7 cycle time PGN 65282 (default: Quaternion)	UNS16	0: deactivated (default) 10...10000 ms cycle time	rw
0x3061	TxPGN7 priority PGN 65282 (default: Quaternion)	UNS8	0...7 (default: 3)	rw
0x3062	TxPGN7 LSB PGN 65282 (default: Quaternion)	UNS8	0x00...0xFF default: 0x02	rw
0x3068	TxPGN7 Mapping PGN 65282	UNS32	0...26 per Byte (default: 0x09080706)	rw
0x3070	TxPGN8 cycle time PGN 65283 (default: Acceleration x, y, z axis)	UNS8	0: deactivated (default) 10...10000 ms cycle time	rw
0x3071	TxPGN8 priority PGN 65283 (default: Acceleration x, y, z axis)	UNS8	0...7 (default: 3)	rw
0x3072	TxPGN8 LSB PGN 65283 (default: Acceleration x, y, z axis)	UNS8	0x00...0xFF default: 0x03	rw
0x3078	TxPGN8 Mapping PGN 65283	UNS32	0...26 per Byte (default: 0x000C0B0A)	rw
0x3080	TxPGN9 cycle time PGN 65284 (default: Angular Rate x, y, z axis)	UNS8	0: deactivated (default) 10...10000 ms cycle time	rw
0x3081	TxPGN9 priority PGN 65284 (default: Angular Rate x, y, z axis)	UNS8	0...7 (default: 3)	rw
0x3082	TxPGN9 LSB PGN 65284 (default: Angular Rate x, y, z axis)	UNS8	0x00...0xFF default: 0x04	rw
0x3088	TxPGN9 Mapping PGN 65284	UNS32	0...26 per Byte (default: 0x00121110)	rw
0x3090	XPGN10 cycle time PGN 65285 (default: Acceleration unfiltered x, y, z axis)	UNS16	0: deactivated (default) 10...10000 ms cycle time	rw
0x3091	TXPGN10 priority PGN 65285 (default: Acceleration unfiltered x, y, z axis)	UNS8	0...7 (default: 3)	rw
0x3092	TXPGN10 LSB PGN 65285 (default: Acceleration unfiltered x, y, z axis)	UNS8	0x00...0xFF default: 0x05	rw
0x3098	TxPGN10 Mapping PGN 65285	UNS32	0...26 per Byte (default: 0x000F0E0D)	rw
0x30A0	TXPGN11 cycle time PGN 65286 (default: Gyro angle x, y, z)	UNS16	0: deactivated (default) 10...10000 ms cycle time	rw
0x30A1	TXPGN11 priority PGN 65286 (default: Gyro angle x, y, z)	UNS8	0...7 (default: 3)	rw
0x30A2	TXPGN11 LSB PGN 65286 (default: Gyro angle x, y, z)	UNS8	0x00...0xFF default: 0x06	rw
0x30A8	TxPGN11 Mapping PGN 65286	UNS32	0...26 per Byte (default: 0x00151413)	rw

Index	Parameter	Data Type	Value	Access
Process data				
0x5000	Read angle values	UNS32	Angle output (according to TxPGN5)	ro
0x5001	Read temperature values	INT8	Temperature in °C	ro

Table 55: Configuration parameters

For permanent saving of the parameters, the "SAVE" command (Index 0x2300) must be sent. The CAN baud rate and device address are stored in the permanent memory during writing but are not immediately applied. A restart of the sensor is necessary to assume the new parameters.

10.5.1 Examples SAE J1939 communication

	CAN-Identifier	D0	D1	D2	D3	D4	D5	D6	D7
		INDEX		CMD	STATUS	DATA0	DATA1	DATA2	DATA3
Request	0x0CEF8001	0x04	0x10	0x01	0x00	0x00	0x00	0x00	0x00
Reply	0x0CEF0180	0x04	0x10	0x01	0x00	0x01	0x00	0x00	0x00

Table 56: Read the firmware version of the sensor (device address 128)

	CAN-Identifier	D0	D1	D2	D3	D4	D5	D6	D7
		INDEX		CMD	STATUS	DATA0	DATA1	DATA2	DATA3
Request	0x0CEF8001	0x10	0x21	0x02	0x00	0x01	0x00	0x00	0x00
Reply	0x0CEF0180	0x10	0x21	0x02	0x00	0x01	0x00	0x00	0x00

Table 57: Activate sensor fusion (device address 128)

10.5.2 Status byte description

Value	Description
0x00	Ok, processing successfully
0xF0	invalid index
0xF1	invalid parameter, parameter out of range
0xF2	EEPROM read-/write-error

Table 58: Status byte

11 Maintenance and Service

11.1 Calibration

Every GEMAC Motus® *BLACKLINE* Xx is calibrated by the manufacturer GEMAC Chemnitz GmbH as standard before delivery.

Even the highest quality sensors have to be recalibrated at certain intervals in order to continue to deliver reliable, safe and error-free measurement results. We therefore recommend regular recalibration. This shall be done exclusively by the manufacturer GEMAC GmbH.

11.2 Customer service

11.2.1 Reshipment

Reshipment of the sensor GEMAC Motus® *BLACKLINE* Xx for calibration or repairing purposes must be executed in the original packaging or an equivalent packaging. Please indicate a short error description and your phone number for further inquiries.

11.2.2 Support

Please indicate the serial number and the firmware revision of your sensor for technical support.

Manufacturer: GEMAC Chemnitz GmbH
Zwickauer Str. 227
09116 Chemnitz / Germany
Phone: +49 371 3377-0
Fax: +49 371 3377-272
Web: www.gemac-chemnitz.com
Mail: info@gemac-chemnitz.de

11.2.3 Warranty and limitation of liability

We will assume a warranty of 24 months for the sensor GEMAC Motus® *BLACKLINE* Xx, commencing from the date of delivery. Any repairs which are required during this time and fall under the manufacturer's obligation to give a warranty will be performed free of charge. Any damage resulting from improper use of the device or from exceeding of the specified technical parameters is not covered by the manufacturer's obligation to give a warranty.

GEMAC Chemnitz GmbH will only be liable for consequential damage resulting from use of the product in case of deliberate action or gross negligence on its own part.

The General Terms and Conditions of GEMAC Chemnitz GmbH apply.

12 Sensor configuration

12.1 Inclination sensor - Programming adapter

Use the separately available programming adapter (starter kit ISPA2 - PR-23999-10) to configure the sensor conveniently. The programming adapter is connected via USB to a PC. The connection of the sensors with the programming adapter is realized through the included CAN adapter cable. The sensor is supplied with power through the adapter. No additional voltage supply is necessary.

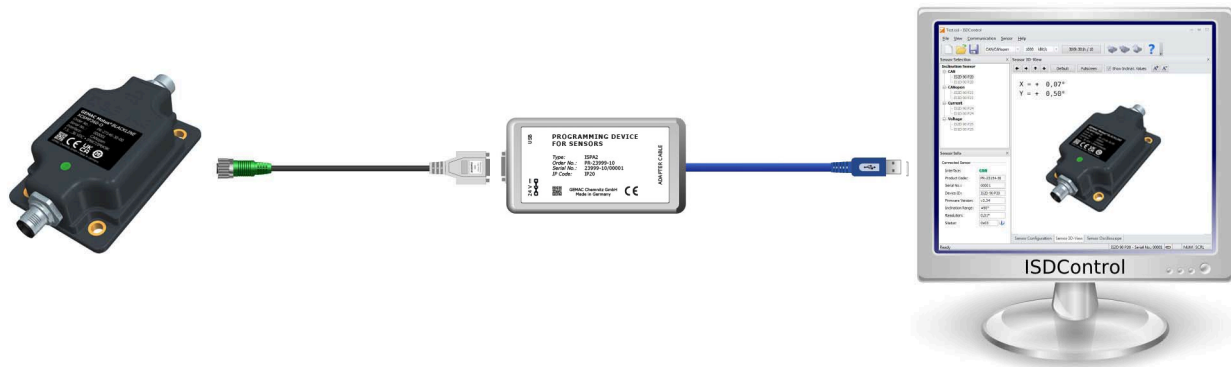

Figure 20: Starter kit

12.2 PC software ISDControl

The parametrization of all possible values is done with the PC software ISDControl, which is included in all starter kits. Each configuration can be stored in a file.

Properties:

- comfortable configuration of all parameters of the sensor
- 3D imaging and display of the current angle
- Oscilloscope display of the current angle for perpendicular angle
- Firmware Download option
- Automatic sensor search for unknown communication parameters



Figure 21: PC software

13 Ordering Information

Article Number	Product Type	Interface
PR-27046-30-00	XC6MP360-C	CAN 2.0 A und B
PR-27146-30-00	XC6MP360-O	CANopen
PR-27746-30-00	XC6MP360-J	SAE J1939
PR-26046-30-00	XB6MP360-C	CAN 2.0 A und B
PR-26146-30-00	XB2MP360-O	CANopen
PR-26746-30-00	XB6MP360-J	SAE J1939
PR-23999-10	ISPA2	programming adapter (Starter kit including programming adapter, cables and PC software)

Table 59: Ordering information