



User manual

Dynamic Inclination Sensors

Version: 1.2

Date: 2022-06-21



IS2BP090-C-DL
IS2BP090-O-DL
IS2BP090-J-DL
IS1BP360-C-DL
IS1BP360-O-DL
IS1BP360-J-DL

GEMAC Chemnitz GmbH
Zwickauer Straße 227
09116 Chemnitz
Germany

Phone: +49 371 3377 - 0
Fax: +49 371 3377 - 272
E-mail: info@gemac-chemnitz.de
Web: www.gemac-chemnitz.de

Revision History

Date	Revision	Changes
05/04/2018	1.0	first release
30/07/2021	1.1	changes CANopen/J1939 interface CANopen Emergency Error Codes updated Housing changes on plastic housing / Outer dimensions not altered Applications "Solar thermal" and "photo-voltaic systems" deleted without replacement
21/06/2022	1.2 valid from serial number 3000	Areas of application (item 2.2 has been expanded) CE Conformity (in table 1) EMC (Table 2 has been completely revised) Reliability data (in table 1)

© Copyright 2022 GEMAC Chemnitz GmbH

This document is subject to change without notice.

We constantly work to further develop of our products. We reserve any changes of the scope of delivery in shape, equipment and technology for ourselves. No claims can be made from the details, illustrations and descriptions in this document.

Any kind of duplication, reprocessing and translation of this document as well as excerpts from it require the written permission of GEMAC Chemnitz GmbH.

All rights according to the copyright remain explicitly reserved for GEMAC Chemnitz GmbH.

Note:

To use the inclination sensors, and for proper understanding of this manual, general knowledge of the field bus system CAN, CANopen and/or SAE J1939 is required.

Table of Contents

1	Safety information.....	1
1.1	Incoming inspection.....	1
1.2	Intended use.....	1
1.3	Incorrect use.....	1
1.4	Requirements for the qualification of personnel.....	1
2	Overview.....	2
2.1	Characteristics.....	2
2.2	Applications.....	2
3	Technical Data.....	3
4	Mounting.....	6
4.1	Fixation.....	6
4.2	Position of mounting holes.....	6
5	Connection.....	7
5.1	General connection information.....	7
5.2	Requirements to the voltage supply.....	7
5.3	Connector Pin Out.....	7
5.4	Internal circuit.....	7
5.5	Bus-Termination Resistor.....	8
6	Functional description.....	9
6.1	Digital Filter.....	9
7	Functional description of the CAN interface.....	10
7.1	Zero Point Adjustment.....	10
7.2	Digital filter.....	10
7.3	Sensor fusion algorithm.....	10
7.4	Status LED.....	10
7.5	Format of the CAN Frames.....	11
7.5.1	Data Part in the CAN Frame.....	11
7.5.2	Status Byte (STATUS).....	11
7.6	Boot Up Message.....	12
7.7	Read/Write device parameters.....	12
7.7.1	Set Parameter Frame.....	13
7.7.2	Reply Parameter Frames.....	14
7.8	Default Device Parameters.....	16
7.9	Transfer of the inclination values.....	16
7.9.1	Polling Mode.....	16
7.9.2	Synchronous Mode.....	17
7.9.3	Cyclic Mode.....	17
7.10	Transfer of alternative output values.....	18
7.10.1	Euler-Angles.....	18
7.10.2	Angular Rate output.....	18
7.10.3	Transfer of acceleration values.....	18

7.11 Configuration of the inclination sensor.....	18
7.11.1 Configuration of Cyclic Mode.....	18
7.11.2 Configuration of the CAN Identifier.....	18
7.11.3 Configuration of the Baud Rate.....	19
7.11.4 Configure Automatic Bus-Off Recovery.....	19
7.11.5 Configuration of Cut-off Frequency.....	19
7.11.6 Configuration of Sensor Fusion.....	19
7.11.7 Configuration of Zero Point Adjustment.....	20
7.11.8 Restoration of Default Device Parameters.....	20
7.11.9 Save Device Parameters.....	20
8 Functional Description CANopen interface.....	21
8.1 Overview of Function.....	21
8.2 CANopen Structure.....	22
8.3 CANopen Device Model.....	22
8.4 COB-IDs.....	22
8.5 Network Management: NMT.....	23
8.6 Process Data: PDO (TPDO1, TPDO2).....	23
8.6.1 PDO Communication Types.....	25
8.6.1.1 Individual Request (Polling).....	25
8.6.1.2 Cyclic Transmission.....	25
8.6.1.3 Synchronous Transmission.....	25
8.6.1.4 Event-controlled transmission on inclination change (manufacturer specific).....	25
8.7 Service Data: SDO.....	26
8.8 Object Dictionary.....	26
8.8.1 Communication Parameters (according to CiA DS-301).....	27
8.8.1.1 Error Register (1001h).....	28
8.8.1.2 Manufacturer Status Register (1002h).....	29
8.8.1.3 Pre-defined Error Field (1003h).....	29
8.8.1.4 Saving (1010h) and Loading (1011h) of Parameters.....	29
8.8.1.5 Transmit PDO – Transmission Type (1800h / 1801h).....	30
8.8.2 Manufacturer Specific Part.....	31
8.8.2.1 Automatic Bus-Off Recovery (2002h).....	32
8.8.2.2 Digital Filter Settings (3000h).....	32
8.8.2.3 TPDO1 Transmission on Inclination Change (3001h).....	32
8.8.3 Device Profile Specific Part (according to CiA DS-410).....	33
8.8.3.1 Resolution (6000h).....	33
8.8.3.2 Inclination values longitudinal and lateral (6010h and 6020h).....	33
8.8.3.3 Operating Parameters (6011h and 6021h).....	33
8.8.3.4 Zero Point Adjustment: Preset Value, Offset Value, Differential Offset Value (60x1/2/3h).....	34
8.9 Emergency Objects.....	35
8.10 Failure monitoring.....	36
8.10.1 Nodeguarding / Lifeguarding.....	36
8.10.2 Heartbeat.....	36

8.11 LSS: Layer Setting Service (according to CiA DSP-305).....	37
8.11.1 Setting of Node-ID and Baud Rate.....	37
8.12 Automatic Baud Rate Detection (according to CiA AN-801).....	37
8.13 Status LED (according to CiA DR-303-3).....	38
9 Functional Description J1939 Interface.....	39
9.1 Message format.....	39
9.2 Device name and address.....	39
9.3 Process data (Transmit PGNs).....	40
9.4 Sensor configuration.....	43
9.4.1 Examples J1939 communication.....	45
9.4.2 Status byte description.....	46
10 Service.....	47
10.1 Calibration.....	47
10.2 Service.....	47
10.2.1 Reshipment.....	47
10.2.2 Support.....	47
10.2.3 Warranty and limitation of liability.....	47
11 Sensor configuration.....	48
11.1 Inclination sensor programming adapter.....	48
11.2 PC software ISDControl.....	49
12 Ordering Information.....	50

List of Tables

Table 1: Technical Data.....	4
Table 2: Electromagnetic Compatibility (EMC).....	4
Table 3: Filter selection.....	9
Table 4: Status and Error Display through Status LED.....	10
Table 5: Format of the CAN Frames.....	11
Table 6: Status Byte Typ: IS1BP360-x-DL.....	11
Table 7: Status Byte Typ: IS2BP090-x-DL.....	11
Table 8: "Boot Up" Message.....	12
Table 9: Supported FSC and Parameters of the Set Parameter Frames (Request).....	13
Table 10: Function Codes and Parameters of the Reply Parameter Frames.....	15
Table 11: Device parameters default settings.....	16
Table 12: Request frame: inclination values (FSC = 00h).....	16
Table 13: Reply frame: inclination values Typ IS1BP360-x-DL (FSC = 00h).....	16
Table 14: Reply frame: inclination values Typ IS2BP090-x-DL (FSC = 00h).....	16
Table 15: CAN Identifier.....	19
Table 16: Restore Default Device Parameters.....	20
Table 17: Save Device Parameters.....	20
Table 18: Calculation of the COB-IDs for Pre-defined Connection Set.....	23
Table 19: TPDO1 Default mapping Type: IS1BP360-O-DL.....	24
Table 20: TPDO1 Default mapping Type: IS2BP090-O-DL.....	24
Table 21: TPDO2 Default mapping Type: IS1BP360-O-DL, IS2BP090-O-DL.....	24
Table 22: Mappable objects.....	24
Table 23: Communication Parameters in the Object Dictionary.....	28
Table 24: Error Register (1001h).....	28
Table 25: Manufacturer Status Register (1002h).....	29
Table 26: Error Entry in Pre-defined Error Field (1003h).....	29
Table 27: Transmit PDO - Transmission Type.....	30
Table 28: Manufacturer Specific Part of the Object Dictionary.....	31
Table 29: Filter selection.....	32
Table 30: Device Profile Specific Part of the Object Dictionary.....	33
Table 31: Operating Parameters (6011h and 6021h).....	34
Table 32: Zero Point Adjustment.....	34
Table 33: Emergency Object.....	35
Table 34: Emergency Error Code.....	35
Table 35: Emergency: Manufacturer Specific Error Field.....	35
Table 36: LSS Baud Rate Index according to CiA DSP-305.....	37
Table 37: Status and Error Display of the Two-Color LED.....	38
Table 38: Transmit PGN 1 - 61459 Slope Sensor Information.....	41
Table 39: Transmit PGN 2 – 61481 Slope Sensor Information 2.....	41
Table 40: Transmit PGN 3 – 61482 Angular Rate Information.....	41
Table 41: Transmit PGN 4 – 61485 Acceleration Sensor.....	41

Table 42: Transmit PGN 5 - Inclination angle for IS2BP090-J-DL.....	42
Table 43: Transmit PGN 5 - Inclination angle for IS1BL360-J-DL.....	42
Table 44: Transmit PGN 6 - Euler angles.....	42
Table 45: Transmit PGN 7 – Quaternion.....	42
Table 46: Transmit PGN 8 – Acceleration.....	42
Table 47: Transmit PGN 9 – Angular rate.....	42
Table 48: Configuration parameters.....	45
Table 49: Read the firmware version of the sensor (device address 128).....	45
Table 50: Activate sensor fusion (device address 128).....	45
Table 51: Statusbyte.....	46
Table 52: Ordering information.....	50

List of Figures

Figure 1: Measurement axes orientation (factory default settings).....	5
Figure 2: Mounting holes (dimensions in mm).....	6
Figure 3: M12 Plug Connector Pin Out CAN Bus.....	7
Figure 4: M12 Female Connector Pin Out CAN Bus.....	7
Figure 5: internal circuit.....	8
Figure 6: Impulse and amplitude response of the two filters.....	9
Figure 7: Operational Principle of the Cyclic Mode.....	17
Figure 8: CANopen structure.....	22
Figure 9: NMT State diagram.....	23
Figure 10: SDO Protocol – Access to Object Dictionary.....	26
Figure 11: J1939 CAN-Identifier.....	39
Figure 12: Starter kit.....	48
Figure 13: PC software.....	49

1 Safety information

1.1 Incoming inspection

Unpack the device immediately after you received it and check the entire delivery for completeness. If transport damage is to be assumed, inform the delivery agent within 72 hours and keep the packaging for inspection. The device must only be transported in its original or equivalent packaging.

1.2 Intended use

The inclination sensor ISxBPxxx-x-DL is a device consisting of an electronic sensor and an integrated evaluation unit. The device is designed to determine inclinations, accelerations and angular rates in large-scale fixed installations of industrial automation as well as non-road mobile machinery or means of transport for persons or goods like agricultural and forestry machinery, utility vehicles or crane and hoisting technology.

GEMAC Chemnitz GmbH assumes no liability for losses or damages arising from the use of the product, either directly or indirectly. This applies in particular to use of the product that does not conform to this intended purpose and is not described in this document.

1.3 Incorrect use

The inclination sensor ISxBPxxx-x-DL is not a safety component according to the EC Machinery Directive (2006/42/EC). It must not be used in explosion hazardous areas. Any use that is not described in section 1.2 "Intended use" is prohibited. Any use of accessories that is not specifically approved by GEMAC Chemnitz GmbH is at your own risk.

1.4 Requirements for the qualification of personnel

The personnel who work on and with the inclination sensor ISxBPxxx-x-DL must be suitably authorized, trained, and sufficiently qualified. Skilled personnel refers to the following:

- Has received specialist training, which is backed up by additional knowledge and experience according to operation and service of the inclination sensor and the respective application.
- Knows the relevant technical terms and regulations.
- Can appraise the work assigned to them, recognize potential hazards, and take suitable safety precautions.

2 Overview

2.1 Characteristics

- 1-dimensional inclination sensor with measurement range: 360°
- 2-dimensional inclination sensor with measurement range: $\pm 90^\circ$ (X/Y)
- easy to handle parametrization with GEMAC programming tools
 - intelligent sensor fusion algorithm, configurable for the application
 - configurable filter for vibration suppression
- High sampling rate and bandwidth
- High resolution (0.01°)
- static accuracy independent of sensors orientation
- Compensated cross sensitivity
- Comfortable CAN CANopen or SAE J1939 interface
 - Baud rates from 10 kBit/s to 1 MBit/s
 - Automatic baud rate detection
- UV resistant, impact strength plastic housing
- wide input voltage range (8-36 V)
- low power consumption
- Suitable for industrial use:
 - Temperature range: -40 °C to +80 °C
 - Degree of protection: IP65/67

The 1-dimensional inclination sensors IS1BP360-x-DL are suitable to measure the inclination in the measurement range of 360°. The 2-dimensional inclination sensors IS2BP090-x-DL are suitable to measure the inclination in 2 dimensions (X/Y) in the measurement range of 90°. To ensure a high accuracy, the sensors are calibrated at the factory.

The compact and robust design makes the sensors a suitable angle measurement device in rough surroundings for different applications in industry and vehicle technology. Occurring accelerations caused by e.g. brake applications or cornering events are reliably filtered by an integrated fusion algorithm.

A simple configuration and putting into operation is possible by the digital interface.

2.2 Applications

- Agricultural and forestry machinery
- Construction machinery
- Crane and hoisting technology
- Drilling and foundation equipment
- Machines for the manufacture, transport, compaction and preparation of concrete and mortar
- Road construction and road maintenance machinery and equipment

3 Technical Data

General Parameters dynamic inclination sensor ¹	IS1BP360-x-DL		IS2BP090-x-DL	
Measurement range	360°		±90°	
Resolution	0,01°			
Static accuracy	typical	max	typical	max
	±0,3°	±0,5°	±0,3°	±0,5°
Dynamic accuracy	typical ±0,5°			
Duration of suppression of external accelerations (configurable)	100 – 10000 ms			
Temperature coefficient (zero point)	typ. ±0,01 °/K			
General Parameters IMU ²	Acceleration sensor		Angular Rate Sensor	
Measurement range	±8 g		±250 °/s	
Resolution	0,244 mg		0,00875 °/s	
In run bias stability	-		typ. 6 °/h	
Angular random walk (ARW)	-		0,2 °/√h	
Temperature coefficient (zero point)	typ. 0,2 mg/K		typ. 0,005 °/s/K	
General Parameters				
Sampling rate	200 Hz			
Operating temperature	-40 °C to +80 °C			
Characteristics				
Interface	ISxBPxx0- C -DL	ISxBPxx0- O -DL	ISxBPxx0- J -DL	
	CAN 2.0 A and B (11- and 29-Bit-ID) according to ISO 11898-2	CANopen according to CiA DS-301, Device profile CiA DSP-410	SAE J1939	
Data rates	10k, 20k, 50k, 100k, 125k, 250k, 500k, 800k Bit/s, 1 MBit/s automatic detection		250k, 500k Bit/s automatic detection	
Functions	Angle request, cyclical and synchronized outputs, parametrization, sensor fusion algorithm, digital filter (critically damped (default) or Butterworth lowpass, 8 th order), configuration via digital interface			
Electrical Parameters				
Supply voltage	8 to 36 V DC			
Current consumption	15 mA @ 24 V			
Necessary overcurrent protective device	400 mA ³			
Maximaler Ausgangsstrom	350 mA			
Mechanical Parameters				
Electrical connector	2 x sensor connector 5-pole M12 (male + female, loop through connection)			
Degree of protection	IP65/67			
Dimensions / Weight	plastic housing (PBT): 66 mm x 90 mm x 36 mm / ca. 200 g			
Reliability according EN ISO 13849-1 ⁴				
MTTF	447 years			
MTTFd	684 years			

1 All indicated angle accuracies are valid after a running time of 10 minutes at 25 °C
Absolute calibration accuracy (at 25 °C): ±0.05°

2 All indicated accuracies are valid after a running time of 10 minutes at 25 °C

3 The electrical power supply has to be designed in a way, that a current of more than 400 mA can flow for maximum 3 s.

4 This product is a standard product and no safety part in accordance with the machinery directive. The calculation is based on an average environment temperature of 40 °C and a usage of 8760 h/a.

CE Conformity	
EC Directives	
RL 2014/30/EU	Harmonisation of the laws of the Member States relating to electromagnetic compatibility
RL 2011/65/EU	Restriction of the use of certain hazardous substances in electrical and electronic equipment
RL 2001/95/EG	General product safety
Harmonized standards	
EN ISO 13766-1:2018	Earth-moving and construction machinery - Electromagnetic compatibility of machines with internal electrical system - Part 1: General EMC requirements under typical EMC environmental conditions
EN 50581:2012	Technical documentation for the assessment of electrical and electronic products with respect to the restriction of hazardous substances
EN 62368-1:2014 +AC:2015	Audio/video, information and communication technology equipment - Part 1: Safety requirements

Table 1: Technical Data

Electromagnetic Compatibility (EMC)			
Transient Emissions			
Radiated disturbance / Radio field strength according to CISPR 25:2008 (ALSE)	broadband and narrowband 30 ... 1000 MHz		
Conducted transients according to ISO 7637-1:2015 ISO 7637-2:2011 ISO 16750-2:2012	pulse amplitudes 0 V +27 V		
Immunity to RF fields			
Anechoic chamber according to ISO 11452-2:2004	20 ... 400 MHz 30 V/m Performance criteria A		
Harness excitation method (BCI) according to ISO 11452-4:2011	20 ... 400 MHz 60 mA Performance criteria A		
Immunity to Conducted Disturbances (on-board power supply 24 VDC)			
Test pulse according to ISO 7637-1:2015 ISO 7637-2:2011 ISO 16750-2:2012	Test pulse	Severity level	Performance criteria
	1 -450 V	III	C
	2a +55 V	III	A
	2b +20 V	III	C
	3a -220 V	III	A
	3b +220 V	III	A
	start profile 15 V	II	A
	load shedding +58 V	Ri = 2 Ω	C
Immunity to Electromagnetic Discharge (ESD)			
ESD according to ISO 10605:2008	discharge combination 150 and 330 pF / 2 kΩ Contact discharge and air discharge ± 4 kV Performance criteria A Contact discharge ± 6 kV and air discharge ± 8 kV Performance criteria C		

Table 2: Electromagnetic Compatibility (EMC)

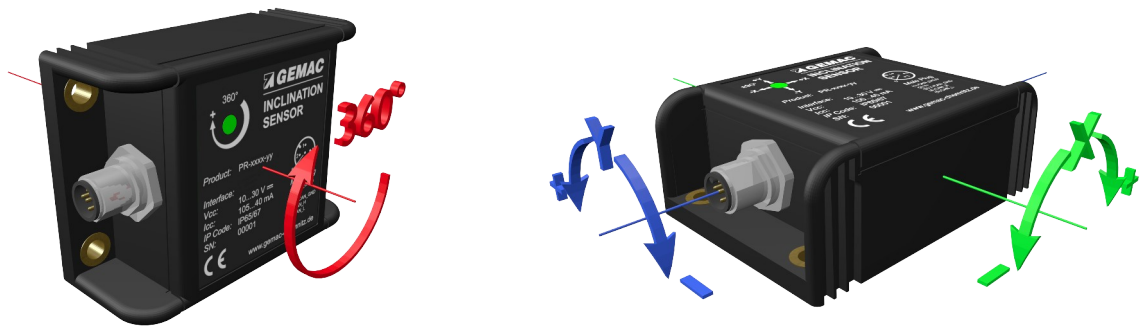

Figure 1: Measurement axes orientation (factory default settings)

4 Mounting

4.1 Fixation

The Sensor has to be screwed in place by using 4 hexagon socket screws M5 according to DIN 912 A2 and 4 hexagon nuts M5 according to DIN 934 with a torque of 3 Nm in a manner, that one full thread of the screw is overlapping minimum.

4.2 Position of mounting holes

Holes to mount the sensor (figure 2) are situated in the base plate of the inclination sensor.

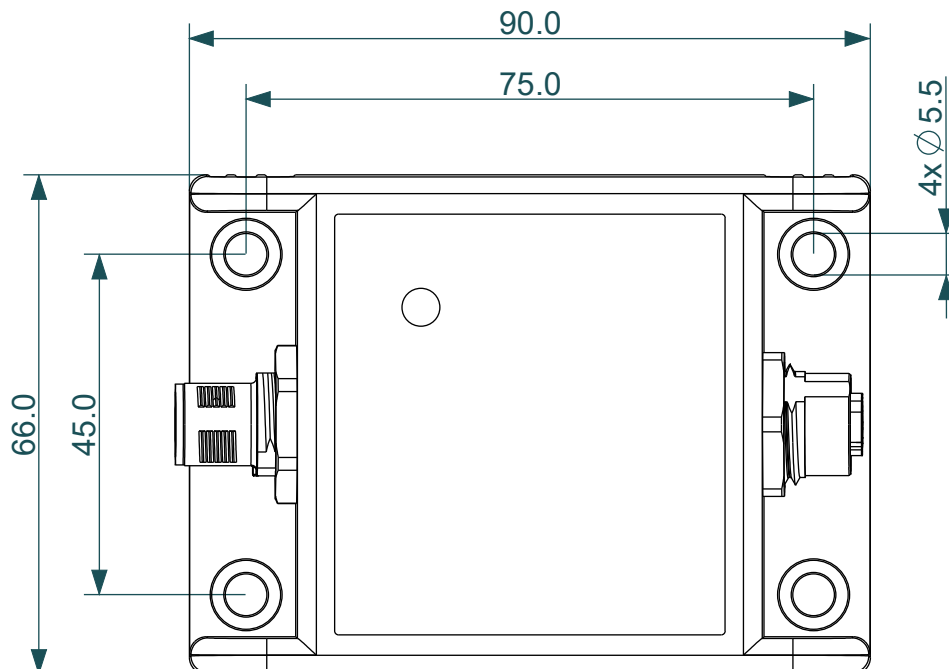

Figure 2: Mounting holes (dimensions in mm)

5 Connection

5.1 General connection information

The inclination sensor is equipped with a 5-pole round male connector M12 (A-coded) according to IEC 61076-2-101. There is an additional 5-pole round female connector (A-coded) available. The voltage supply is forwarded from the male connector to the female connector. That allows to power further sensors with one cable harness. It is necessary to ensure that that current draw of all connected devices is less than 350 mA total.

5.2 Requirements to the voltage supply

The voltage supply has to be dimensioned in a manner that the voltage values given in table 1 are not exceeded.

The power supply has to be protected with a suitable fuse, that guarantees that a current of more than **400 mA** can flow for **3 s maximum**.

5.3 Connector Pin Out

The pin allocation fulfills CiA DR-303-1 (3 + 4).

Pin	Signal	Allocation
1	CAN_SHLD	Shield
2	V+	Supply voltage (+24 V)
3	V-	GND / 0 V / V-
4	CAN_H	CAN_H bus line
5	CAN_L	CAN_L bus line

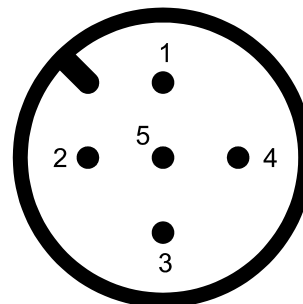

(View from the outside)

Pin	Signal	Allocation
1	CAN_SHLD	Shield
2	V+	Supply voltage (+24 V)
3	V-	GND / 0 V / V-
4	CAN_H	CAN_H bus line
5	CAN_L	CAN_L bus line

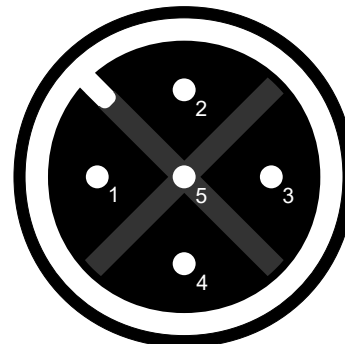

(View from the outside)

5.4 Internal circuit

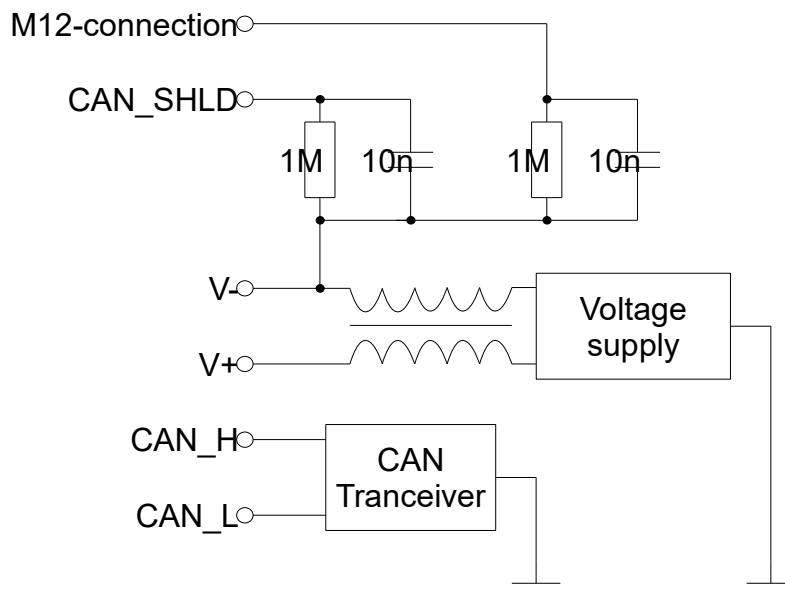

Figure 5: internal circuit

5.5 Bus-Termination Resistor

The inclination sensor does **not** contain an internal termination resistor.

6 Functional description

6.1 Digital Filter

The inclination sensor uses an indirect measuring method based on gravitational acceleration. External accelerations such as caused by brake applications or cornering events of vessels or vibrations do disturb the function of the sensor.

The sensors does provide the opportunity to make the output angle values more robust against disturbing vibrations or external accelerations. There are three different digital filters that can be chosen depending on the application.

The programmable lowpass filter (Butterworth or critically damped) of 8th order are good for suppressing vibrations up to 0.1 Hz.

The sensor fusion algorithm does use the gravitational acceleration information and the rotational speed information of a gyroscope additionally. So external accelerations and vibrations can be suppressed without a remarkable time delay on the output angle value.

Filter	Adjustable frequency range	Applications
Butterworth	0.1 Hz ... 25 Hz	Static inclination measurement with high damping to vibration
Critically damped	0.1 Hz ... 8 Hz	Inclination measurement in applications that requires a certain dynamism, without overshoot at angle changes with good damping
Sensor fusion	100 ms...10 s	Dynamic applications, measuring during acceleration or brake applications or cornering events, measuring without time delay of the signal

Table 3: Filter selection

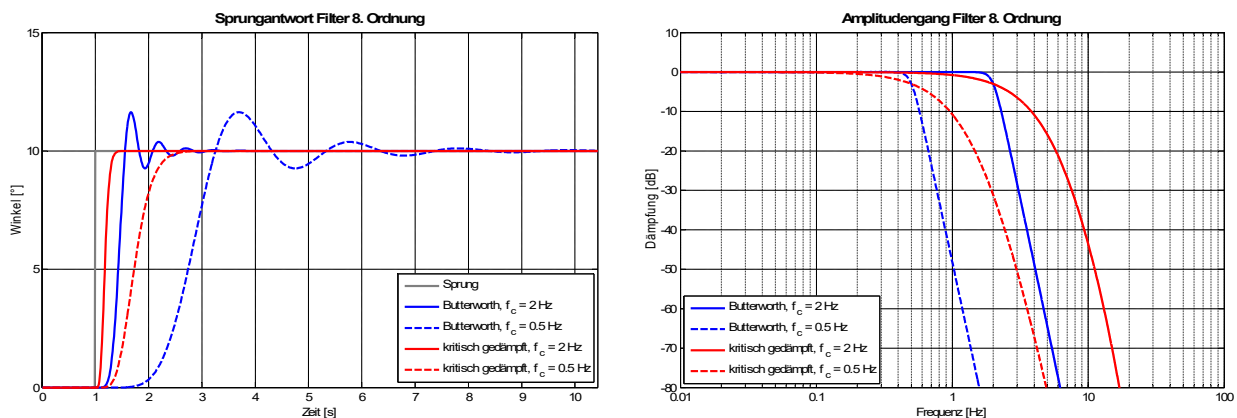

Figure 6: Impulse and amplitude response of the two filters

7 Functional description of the CAN interface

7.1 Zero Point Adjustment

For all inclination sensors, the zero point can be adjusted. This allows to set the zero position in the installed state of the sensor. Therefore the inclination sensors have a memory for a zero offset. Values registered herein are added to the output of the internal measured inclination value.

In case the current position should be set as zero point, the current measured inclination value must be set as negative value in the zero offset register. The inclination sensor is able to perform this kind of Zero Point Adjustment itself (Automatic Zero Point Adjustment). Therefore the user has to send a telegram **without** parameters (FSC = 28h/29h - depending on sensor type, DLC = 1). The sensor then sets the current position at the time of reception of the telegram as negative value in the zero offset register.

7.2 Digital filter





The cut-off frequency is programmable by FSC = 27h (Set Parameter Frame). Values for CF (cut-off frequency) are allowed between 100 (= 0.1 Hz) and 25000/8000 (= 25 Hz/8 Hz). The filter type is selected with the parameter FT.

7.3 Sensor fusion algorithm

The sensor fusion of acceleration sensor and gyroscope can be activated or deactivated by FSC = 2Bh (Set Parameter Frame). The filter duration of the sensor fusion algorithm can be set in a range between 10 ms and 10 s. This parameter is equal to the maximum suppression time of external disturbances. The sensor fusion can be configured independent from the digital filter.

7.4 Status LED

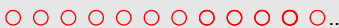
The integrated two-color Status LED signals the current device state (Run LED, green) as well as CAN communication errors that might have occurred (Error LED, red). The color and the flashing frequency of the LED distinguish the different device states as shown in table 4.

Status LED		
Run LED	LED state	Description
	Off	The device is in state Reset or no power supply is connected
	Flickering	Automatic baud rate detection is currently running (active)
	On	The device is in normal operating state
Error LED	LED state	Description
	Off	The device is in working condition
	Single Flash	CAN Warning Limit reached
	On	The device is in state Bus-Off



Legend:  LED off  LED on  LED flickering (50 ms on/off) Duration of one state (○/●): 200 ms

Table 4: Status and Error Display through Status LED

7.5 Format of the CAN Frames

For reading or writing device parameters, and to read the inclination values, two CAN-IDs exists. One ID for receiving data/commands and another one to send the response/confirmation. These IDs are saved in an internal permanent memory (EEPROM) and can be configured freely. CAN 2.0 A (Standard Frame Format) as well as CAN 2.0 B (Extended Frame Format) are supported.

7.5.1 Data Part in the CAN Frame

The data part of all transmission and reception frames always contains a function select code (FSC) and additionally up to seven data bytes depending on the FSC. The length of the data part of the CAN frame is defined in the DLC field (Data Length Code). The general format of the data part is structured as follows:

Byte0	Byte1	Byte2	Byte3	Byte4	Byte5	Byte6	Byte7
FSC	D0/Status	D1	D2	D3	D4	D5	D6

Table 5: Format of the CAN Frames

FSC: **F**unction **S**elect **C**ode – Function code (detailed description in the sections about the operation modes). Each frame of the inclination sensor always contains the FSC of the preceding request as confirmation.

D0-D7: Data bytes, depending on the function select code

Status: Status information which is included in each frame output by the inclination sensor (see section 7.5.2 “Status Byte (STATUS)”).

Frames which are transmitted to the inclination sensor may contain further data bytes beyond the needed ones – those will be discarded. Frames sent by the inclination sensor only contain the data bytes defined by the function select code.

7.5.2 Status Byte (STATUS)

Each frame sent by the inclination sensor contains the recent status of the device in Byte1 (see table 5) of the CAN frame. The status byte is structured as follows:

Bit7	Bit6	Bit5	Bit4	Bit3	Bit2	Bit1	Bit0
reserved	Accuracy warning	reserved	reserved	CmdParam Error	EEPROM Error	Autobaud Detection	Default Param

Table 6: Status Byte Typ: IS1BP360-x-DL

Bit7	Bit6	Bit5	Bit4	Bit3	Bit2	Bit1	Bit0
reserved	Accuracy warning	reserved	reserved	CmdParam Error	EEPROM Error	Autobaud Detection	Default Param

Table 7: Status Byte Typ: IS2BP090-x-DL

- DefaultParam:** The standard device parameters are set. This bit is reset only when a device parameter was changed to a value different from the factory parameters. The inclination sensors are supplied with the standard device parameters, so this bit is set by default (refer to section 7.8 “Default Device Parameters”).
- AutobaudDetection:** The baud rate is set to automatic detection (BR = 0) (refer to section 7.11.3 “Configuration of the Baud Rate”).
- EEPROMError:** While reading/writing on the EEPROM an error occurred, for example data loss. The correct function of the inclination sensor is no longer guaranteed. This bit is reset by reading the status byte (Set Parameter Telegram with FSC = 02h).
- CmdParamError:** A received frame contained a command or parameter error (invalid FSC, too less data bytes, invalid values). This bit is also set if an error occurred in the execution of a function (for example writing/reading error on EEPROM). This bit is reset by reading the status byte (Set Parameter Frame with FSC = 02h).
- AccuracyWarning:** If the maximum values for acceleration or rotation rate are exceeded, the accuracy of the sensor is limited. This bit resets automatically when the sensor operates under the specified conditions again.

7.6 Boot Up Message

After device reset (hardware or software reset) the inclination sensor outputs a “boot up” message twice. With this the correct boot process is displayed and the Set-Parameter-ID is notified (CAN-ID on which the inclination sensor can be parametrized). This frame contains the following information:

“Boot up” message after device reset: Reply-Parameter-ID (default ID: 301h)

FSC	D0	D1	D2	D3	D4	D5	D6
FFh	Status	SID0	SID1	SID2	SID3	SWV0	SWV1

Table 8: “Boot Up” Message

- SID0-3:** Set-Parameter-ID (see section 7.7 “Read/Write device parameters”)
- SWV0-1:** Software version
 Example: SWV0 = 0x44, SWV1 = 0x03 → Software version v3.44)

7.7 Read/Write device parameters

All parameters like inclinations values, CAN-IDs, Baud Rate, Cyclic Time etc. can be set and requested via the **Set Parameter Frames** (Request frame). The inclination sensor confirms each frame with a **Reply Parameter Frame** which also contains the requested data according to FSC. (Reply frame).

7.7.1 Set Parameter Frame

Table 9 shows all the supported function select codes and the parameters of a Set Parameter Frame.

FSC	D0	D1	D2	D3	D4	D5	D6	Description		
00h	-	-	-	-	-	-	-	Read inclination values (incl. cyclic counter in Cyclic Mode)		
02h	-	-	-	-	-	-	-	Read status		
03h	-	-	-	-	-	-	-	Read product number and revision		
04h	-	-	-	-	-	-	-	Read serial number and software version		
0Ah	-	-	-	-	-	-	-	Read Euler angles		
10h	-	-	-	-	-	-	-	Set-Parameter-ID	Read device parameters	
11h	-	-	-	-	-	-	-	Reply-Parameter-ID		
12h	-	-	-	-	-	-	-	Sync-ID		
13h	-	-	-	-	-	-	-	Baud Rate		
14h	-	-	-	-	-	-	-	Automatic Bus-Off Recovery		
15h	-	-	-	-	-	-	-	Cyclic Time		
16h	-	-	-	-	-	-	-	Cyclic Mode		
17h	-	-	-	-	-	-	-	Cut-off Frequency Digital Filter, Filter selection		
18h ¹	-	-	-	-	-	-	-	Zero Offset		
18h ²	-	-	-	-	-	-	-	Zero Offset X		
19h ²	-	-	-	-	-	-	-	Zero Offset Y		
1Bh	-	-	-	-	-	-	-	Read sensor fusion configuration		
20h	ID0	ID1	ID2	ID3	-	-	-	Set-Parameter-ID*		Write device parameters
21h	ID0	ID1	ID2	ID3	-	-	-	Reply-Parameter-ID*		
22h	ID0	ID1	ID2	ID3	-	-	-	Sync-ID*		
23h	BR	-	-	-	-	-	-	Baud Rate*		
24h	ABOR	-	-	-	-	-	-	Automatic Bus-Off Recovery		
25h	ZYZ0	ZYZ1	-	-	-	-	-	Cyclic Time		
26h	ZYM	-	-	-	-	-	-	Cyclic Mode		
27h	FG0	FG1	FT	-	-	-	-	Cut-off Frequency Digital Filter, Filter selection		
28h ¹	OF0	OF1	-	-	-	-	-	Zero Offset		
28h ²	OFX0	OFX1	-	-	-	-	-	Zero Offset X		
29h ²	OFY0	OFY1	-	-	-	-	-	Zero Offset Y		
2Bh	EN	FL0	FL1	-	-	-	-	Configuration sensor fusion		
40h	'L'	'O'	'A'	'D'	-	-	-	Load default device parameters (factory defaults)		
50h	'S'	'A'	'V'	'E'	-	-	-	Write device parameters in EEPROM		
E7h	-	-	-	-	-	-	-	Read Gyro raw data (angular rate)		
E8h	-	-	-	-	-	-	-	Read acceleration raw data		
FFh	'R'	'E'	'S'	'E'	'T'	-	-	Software reset		
FFh	-	-	-	-	-	-	-	Read alive frame ("Boot Up" Message)		

Table 9: Supported FSC and Parameters of the Set Parameter Frames (Request)

¹ type only: IS1BP360-x-DL

² type only: IS2BP090-x-DL

* Changes to communication parameters such as ID and Baud Rate will take effect after reboot.

7.7.2 Reply Parameter Frames

As confirmation to the correctly received Set Parameter Frame each Reply Parameter Frame contains the identical FSC. The error bits of the status byte indicate insufficient or invalid parameters or errors that occurred while writing into the nonvolatile memory. (refer to section 7.5.2 “Status Byte (STATUS)”). The structure of the Reply Parameter Frames in dependence to the FSC is shown in Table 10.

FSC	D0	D1	D2	D3	D4	D5	D6	Description
00h	Status	WX0	WX1	WY0	WY1	(CNT0)	(CNT1)	Read inclin. values (incl. cyclic counter in Cyclic Mode)
02h	Status	-	-	-	-	-	-	Read status
03h	Status	PR0	PR1	PR2	PR3	RV0	RV1	Read product number and revision
04h	Status	SN0	SN1	SN2	SN3	SWV0	SWV1	Read serial number and software version
0Ah	Status	P0	P1	R0	R1	-	-	Read Euler angles (Pitch and Roll)
10h	Status	ID0	ID1	ID2	ID3	-	-	Set-Parameter-ID
11h	Status	ID0	ID1	ID2	ID3	-	-	Reply-Parameter-ID
12h	Status	ID0	ID1	ID2	ID3	-	-	Sync-ID
13h	Status	BR	-	-	-	-	-	Baud Rate
14h	Status	ABOR	-	-	-	-	-	Automatic Bus-Off Recovery
15h	Status	ZYZ0	ZYZ1	-	-	-	-	Cyclic Time
16h	Status	ZYM	-	-	-	-	-	Cyclic Mode
17h	Status	FG0	FG1	FT	-	-	-	Cut-off Frequency Digital Filter, Filter selection
18h ¹	Status	OF0	OF1	-	-	-	-	Zero Offset
18h ²	Status	OFX0	OFX1	-	-	-	-	Zero Offset X
19h ²	Status	OFY0	OFY1	-	-	-	-	Zero Offset Y
1Bh	Status	EN	FL0	FL1	-	-	-	Configuration sensor fusion
20h	Status	-	-	-	-	-	-	Set-Parameter-ID*
21h	Status	-	-	-	-	-	-	Reply-Parameter-ID*
22h	Status	-	-	-	-	-	-	Sync-ID*
23h	Status	-	-	-	-	-	-	Baud Rate*
24h	Status	-	-	-	-	-	-	Automatic Bus-Off Recovery
25h	Status	-	-	-	-	-	-	Cyclic Time
26h	Status	-	-	-	-	-	-	Cyclic Mode
27h	Status	-	-	-	-	-	-	Cut-off Frequency Digital Filter, Filter selection
28h ¹	Status	-	-	-	-	-	-	Zero Offset
28h ²	Status	-	-	-	-	-	-	Zero Offset X
29h ²	Status	-	-	-	-	-	-	Zero Offset Y
2Bh	Status	-	-	-	-	-	-	Configuration sensor fusion
40h	Status	-	-	-	-	-	-	Load default device parameters (factory defaults)
50h	Status	-	-	-	-	-	-	Geräteparameter im EEPROM speichern
E7h	Status	GX0	GX1	GY0	GY1	GZ0	GZ1	Read Gyro raw data (angular rate)
E8h	Status	AX0	AX1	AY0	AY1	AZ0	AZ1	Read acceleration raw data

¹ type only: IS1BP360-x-DL

² type only: IS2BP090-x-DL

* Changes to communication parameters such as ID and Baud Rate will take effect after reboot.

FFh	Status	Set-Param ID	Set-Param ID	Set-Param ID	Set-Param ID	SWV0	SWV1	Alive frame ("Boot Up" Message) Software reset (2 messages with FSC = FFh)
-----	--------	--------------	--------------	--------------	--------------	------	------	---

Table 10: Function Codes and Parameters of the Reply Parameter Frames

7.8 Default Device Parameters

The inclination sensor is delivered with the default device parameters shown in table 11. These can be restored by a Set Parameter Frame with FSC = 40h (see section 7.7 “Read/Write device parameters”).

Parameter	Default Value	Description
Set-Parameter-ID	300h	CAN 2.0 A Standard Frame
Reply-Parameter-ID	301h	CAN 2.0 A Standard Frame
Sync-ID	100h	CAN 2.0 A Standard Frame
Baud Rate (BR)	0	Automatic Baud Rate Detection
Automatic Bus-Off Recovery	0	deactivated
Cyclic Time (CYT)	250	250 ms
Cyclic Mode (CYM)	0	deactivated
Cut-off Frequency (CF); filter type	5000; 2	5000 mHz = 5 Hz; critically damped filter
Sensor fusion; suppression time	1; 5000	Sensor fusion activated, 5000 ms = 5 s
Zero Offset	0	Off

Table 11: Device parameters default settings

These default settings will also be set if invalid device parameters are read from the nonvolatile memory after device reset. If the default settings have been restored this is displayed by the status bit STATUS:DefaultParam = 1.

7.9 Transfer of the inclination values

For the transfer of the inclination values the sensor supports following modes:

- Polling Mode
- Synchronous Mode
- Cyclic Mode

All three modes are active at any time and usable at the same time. Mode-switching is not necessary.

7.9.1 Polling Mode

The polling mode is always available. The inclination value(s) of the sensor can be requested via a **Set Parameter Frame**. The inclination sensor replies to that frame via a **Reply Parameter Frame**. Both frames are structured as follows:

FSC	D0	D1	D2	D3	D4	D5	D6
00h	-	-	-	-	-	-	-

Table 12: Request frame: inclination values (FSC = 00h)

FSC	Status	D1	D2	D3	D4	D5	D6
00h	Status	Angle0	Angle1	-	-	-	-

Table 13: Reply frame: inclination values Typ IS1BP360-x-DL (FSC = 00h)

FSC	Status	D1	D2	D3	D4	D5	D6
00h	Status	AngleX0	AngleX1	AngleY0	AngleY1	-	-

Table 14: Reply frame: inclination values Typ IS2BP090-x-DL (FSC = 00h)

Angle0/1: Typ IS1BP360-x-DL: Angle value
 Format: 16 bit unsigned integer value (0 ... 35999)
 Conversion:: Value / 100 = angle value
 Example: 1065 / 100 = 10,65°

AngleX/Y0/1: Typ IS2BP090-x-DL: Angle value of the X/Y-axis
 Format: 16 bit signed value, complement on two (-9000 ... +9000)
 Conversion:: Value / 100 = angle value

7.9.2 Synchronous Mode

The synchronous transmission is used to receive inclination values from more than one sensor at the same time. Therefore the sensor provides a synchronization frame (Default: Sync-ID = 100h). The synchronization frame is a broadcast message to all CAN nodes **without** user data (DLC = 0). This synchronization frame is transmitted from a bus node (usually the master) cyclically at fixed intervals. All inclination sensors read their current value after reception of the synchronization frame and then transmit the inclination values directly as soon as the bus permits. The reply frame to a synchronization frame is the same as in polling mode (Table 13/14).

7.9.3 Cyclic Mode

The inclination sensor supports the cyclical transmission of the recent position (angle position) after the expiration of a defined time interval. This operation mode can be (de)activated separately and the needed time interval (Cyclic Time) can be parametrized freely. Corresponding to the operational principle shown in figure 7 the inclination sensor outputs the recent position value in periodical intervals (Cyclic Time) with a Reply Parameter Frame as in the polling mode with additional counter in the following data bytes (table 13). This 16-bit counter is increased after the end of the set Cycle Time - regardless of whether the telegram was sent or not. Thus, the temporal relation in case of lost frames can be restored.

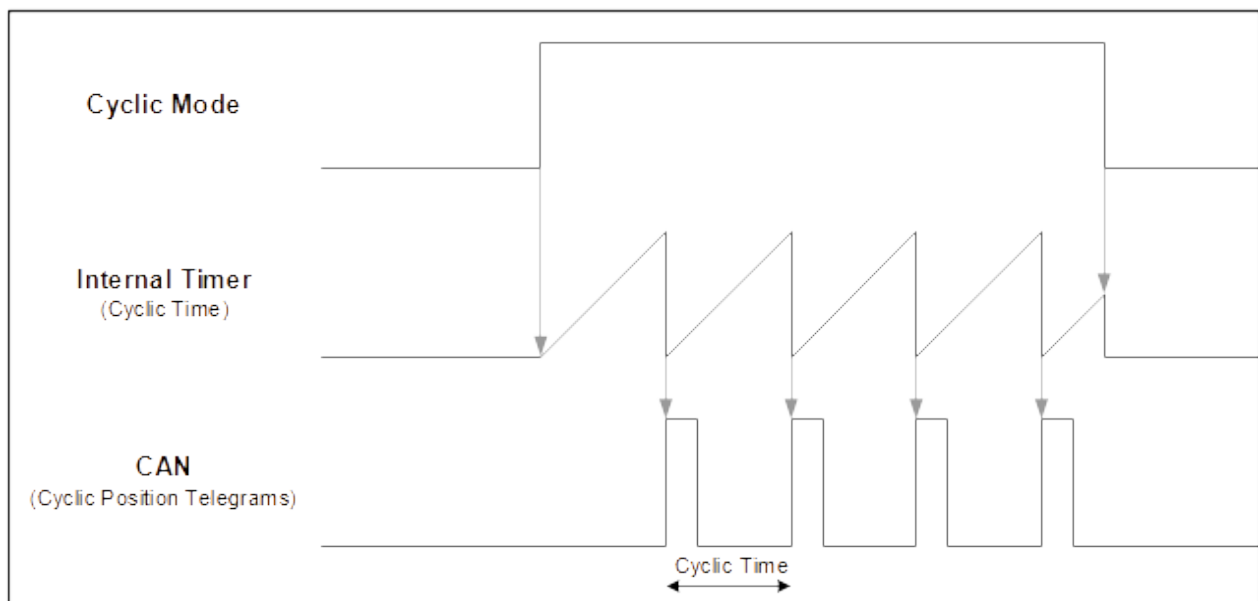

Figure 7: Operational Principle of the Cyclic Mode

7.10 Transfer of alternative output values

7.10.1 Euler-Angles

Using FSC 0Ah, the Euler-Angles Pitch and Roll can be read. The Pitch angle equals the inclination x-axis of the sensor (measurement range $\pm 90^\circ$). The Roll angle is the rotation angle around the Pitch axis (measurement range $\pm 180^\circ$). For a Pitch angle around $\pm 90^\circ$ the value for the Roll angle is undefined.

Format: 16 bit signed value

Conversion: $\text{value}/100 = \text{angle value}$

7.10.2 Angular Rate output

The angular rate values of all 3 axes of the sensor can be requested using FSC E7h.

Format: 16 bit signed value

Conversion: $\text{value} * 7/800 = \text{angular rate in } ^\circ/\text{s}$ (measurement range $\pm 250^\circ/\text{s}$)

7.10.3 Transfer of acceleration values

FSC E8h returns the acceleration values of the sensor in all 3 axes.

Format: 16bit signed value

Conversion: $\text{value}/4096 = \text{acceleration in g}$ (measurement range $\pm 8\text{g}$)

7.11 Configuration of the inclination sensor

7.11.1 Configuration of Cyclic Mode

CYZ0/1: Cyclic Time in ms
Format: 16 bit unsigned integer value (1 ... 65535)

CYM: (De)activate Cyclic Mode
= 0 → Cyclic Mode deactivated
= 1 → Cyclic Mode activated

The section 7.9.3 "Cyclic Mode" contains a detailed description of the usage of the Cyclic Mode.

7.11.2 Configuration of the CAN Identifier

ID0-3: CAN Identifier (ID), 11-Bit-ID (CAN 2.0 A) or 29-Bit-ID (CAN 2.0 B)
Format: 32 bit value with the following structure:

ID3								ID2								ID1								ID0							
7	6	5	4	3	2	1	0	7	6	5	4	3	2	1	0	7	6	5	4	3	2	1	0	7	6	5	4	3	2	1	0
0								-								11-Bit-ID (CAN 2.0 A)															
1								-								29-Bit-ID (CAN 2.0 B)															

Table 15: CAN Identifier

Example: CAN-ID = 361h (29-Bit-ID, CAN 2.0 B)
 ID0 = 61h, ID1 = 03h, ID2 = 00h, ID3 = 80h

If a CAN-ID is set newly, it must not be used by another frame type. If this occurs the error bit STATUS:CmdParamError is set in the Reply Parameter Frame and the CAN-ID is refused.

7.11.3 Configuration of the Baud Rate

BR: Code of a Baud Rate
 Format: 8 bit unsigned integer value (0 ... 10)
 Code: 0: Automatic Baud Rate Detection
 1: 10 kBit/s 2: 20 kBit/s 3: 50 kBit/s
 4: 100 kBit/s 5: 125 kBit/s 6: 250 kBit/s
 7: 500 kBit/s 8: 800 kBit/s 9: 1 Mbit/s

7.11.4 Configure Automatic Bus-Off Recovery

ABOR: Enable/Disable Automatic Bus-Off Recovery
 = 0 → Enable Automatic Bus-Off Recovery (Device remains in the state Bus-Off)
 = 1 → Disable Automatic Bus-Off Recovery (Device starts up again)

7.11.5 Configuration of Cut-off Frequency

CF0/1: Cut-off Frequency in mHz
 Format: 16 bit unsigned integer value (100 ... 25,000/8000)
 FT: 0 Digital Filter deactivated
 1 Butterworth Filter activated
 2 Critically Damped Filter activated

The section 6.1 "Digital Filter" contains a detailed description.

7.11.6 Configuration of Sensor Fusion

EN: 0 Sensor Fusion deactivated
 1 Sensor Fusion activated (factory setting)
 FL: duration of suppression of external disturbances in milliseconds
 at activated sensor fusion algorithm
 Format: 16-Bit unsigned integer value (100 ... 10000)

7.11.7 Configuration of Zero Point Adjustment

OF: Typ: IS1BP360-x-DL: Zero Offset
Format: 16 bit unsigned integer value (0 ... 35.999)

OFX/OFY: Typ: IS2BP090-x-DL : Zero Offset X/Y
Format: 16 bit signed value, two's complement (-9000 ... +9000)

The section 7.1 "Zero Point Adjustment" contains a detailed description.

7.11.8 Restoration of Default Device Parameters

The sensor can be reset to default device parameters by writing the signature "LOAD" to the sensor (FSC = 40h). Thus the default parameters with the exception of the ID and the Baud Rate are immediately active again. After a software reset of the sensor or a hardware reset, the factory parameter of the IDs and the baud rate take effect again.

D0	D1	D2	D3
'L'	'O'	'A'	'D'
4Ch	4Fh	41h	44h

Table 16: Restore Default Device Parameters

The section 7.8 "Default Device Parameters" contains a detailed description.

7.11.9 Save Device Parameters

If parameters are changed in the sensor, they take effect immediately, except for the IDs and the Baud Rate. Thus the new parameters are still active after a reset, these must be stored in the internal nonvolatile memory. This is done by writing the signature "SAVE" on the FSC = 50h.

D0	D1	D2	D3
'S'	'A'	'V'	'E'
53h	41h	56h	45h

Table 17: Save Device Parameters

8 Functional Description CANopen interface

8.1 Overview of Function

The inclination sensors IS1BP360-O-DL and IS2BP090-O-DL contain a standardized CANopen interface according to CiA DS-301 and a device profile according to CiA DSP-410. All measured values and parameters are accessible through the object dictionary (OD). The individual configuration can be saved in the internal permanent memory (EEPROM). The following CANopen functions are available:

- two transmission data objects (TPDO1, TPDO2) dynamically mappable in four possible operating modes:
 - Individual request via remote transmit request message frame (RTR)
 - Cyclic transmission at defined intervals
 - Event-controlled transmission on inclination change
 - Synchronous transmission after receiving a SYNC message frame
- One Service Data Object (Default SDO)
- Error messages by Emergency Object (EMCY) with support of the
 - General Error Register
 - Manufacturer specific status register (Manufacturer Status)
 - List of errors (Pre-defined Error Field)
- Heartbeat and Nodeguarding / Lifeguarding monitoring mechanisms
- Store and load function of all parameters (Store and Load Parameter Field)
- Condition and error information by two-colored LED (according to CiA DR-303-3)

Further manufacturer and profile specific characteristics exist in addition to the CiA DS-301 functionality:

- Configurable cut-off frequency (digital filter)
- Sensor fusion algorithm
- Configuration of the minimum angle change for TPDO1 transmit event
- Direction switch of the inclination value
- Configurable zero point of the inclination value
- Setting of the Node-ID as well as the baud rate via LSS service according to CiA DSP-305
- Automatic baud rate detection according to CiA AN-801

8.2 CANopen Structure

CANopen is a CAN-based open protocol standard in automation and was standardized in association with “CAN in Automation” (CiA). Like virtually all field buses CANopen is based also on the ISO/OSI 7-layer model. The protocol makes use of the CAN bus as a transmission medium and defines the elements for network management, the use of the CAN identifier (message address), the temporal behavior on the bus, the type of data transfer and application profiles. This is to ensure that CANopen devices from different manufacturers can be combined.

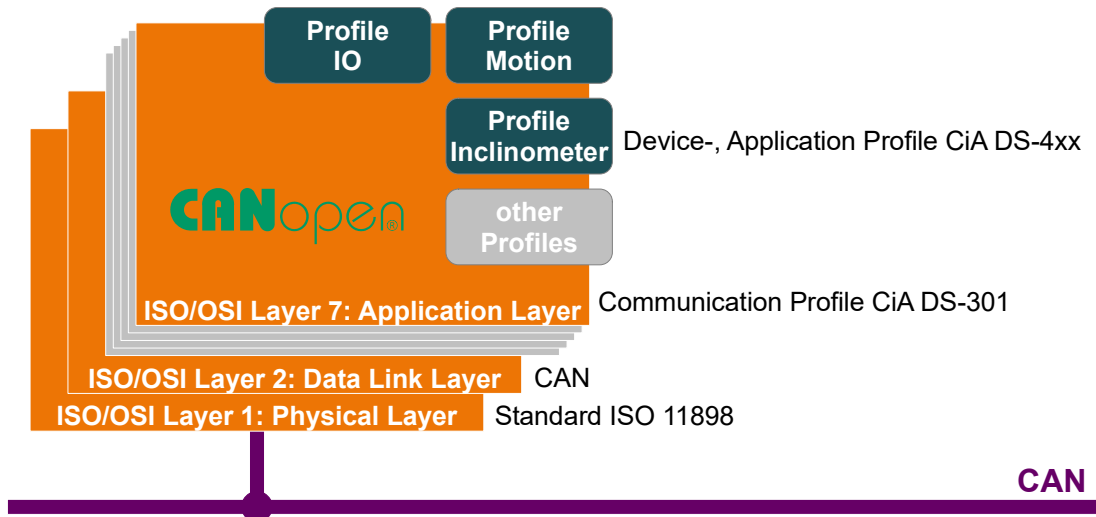

Figure 8: CANopen structure

CANopen describes the ISO / OSI layer 7 (application layer) as a communication profile that was specified in the CiA standard CiA DS-301. The standard defines the method of communication for all devices consistently. In addition, more device and application profiles for specific classes of devices and applications in the CiA standard DS-4xx are defined.

8.3 CANopen Device Model

The exchange of data between CANopen devices is realized via data objects. The CANopen communication profile thus provides for the following types of objects. The process data objects (PDO) are high-priority messages used for the exchange of process data. Access to the object dictionary of a device is done via the service data objects (SDOs). Network management objects are used to control the state machine of the CANopen device and to monitor the nodes. Furthermore, there are special objects for error messages (Emergency), Synchronization (SYNC) and time stamp. Every CANopen device has a CANopen object dictionary, in which the parameters for all CANopen objects are registered.

8.4 COB-IDs

The CAN identifier of the communication objects is determined according to the Pre-defined connection set at each reset (communication, application and hardware reset), depending on the selected Node-ID. Table 18 shows the calculation base with the default values (Node-ID = 10).

Communication object (COB)	Calculation of the COB-ID	Default value (Node-ID = 10)
NMT	0h	0h
SYNC	80h	80h
EMCY	80h + Node-ID	8Ah
TPDO1	180h + Node-ID	18Ah
Default SDO (Client > Server)	280h + Node-ID	28Ah
Default SDO (Server > Client)	600h + Node-ID	60Ah
Heartbeat	580h + Node-ID	58Ah
NMT	700h + Node-ID	70Ah

Table 18: Calculation of the COB-IDs for Pre-defined Connection Set

8.5 Network Management: NMT

9 shows the NMT state machine of a CANopen device. After **Initialization** the device automatically goes into the state **Pre-Operational**. The device sends a **Boot-Up Message**. In this state it can be configured via the object dictionary. The service data objects (SDO) are already active. The process data objects, however, are still locked.

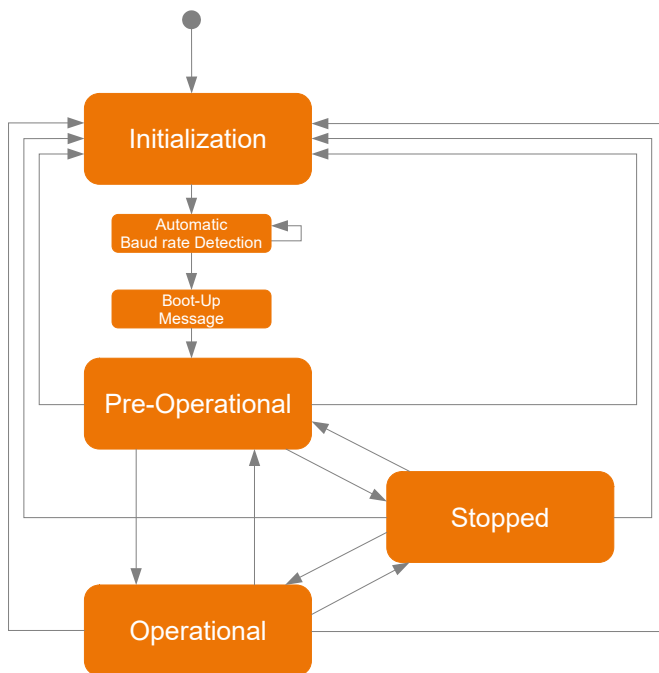

Figure 9: NMT State diagram

By sending the CAN message "Start Remote Node" the unit will go into the state **Operational**. Now the process data objects are active. In **Stopped** state, no communication with the exception of Nodeguarding and Heartbeat is possible.

8.6 Process Data: PDO (TPDO1, TPDO2)

Each inclination sensor has two transmit process data objects (TPDO1 and TPDO2). TPDO1 contains the current values of inclination (axial or longitudinal and lateral) by default. The PDO mapping of the measured values is dynamically adjusted. The default mapping is shown in Table 19/20.

Data part of the CAN Frame of the TPDO1							
Byte0	Byte1	Byte2	Byte3	Byte4	Byte5	Byte6	Byte7
Inclination value axial (OV: 6010h)		unused					

Table 19: TPDO1 Default mapping Type: IS1BP360-O-DL

Data part of the CAN Frame of the TPDO1							
Byte0	Byte1	Byte2	Byte3	Byte4	Byte5	Byte6	Byte7
Inclination value longitudinal (X-Axis, OV: 6010h)		Inclination value lateral (Y-Axis, OV: 6020h)		unbenutzt			

Table 20: TPDO1 Default mapping Type: IS2BP090-O-DL

TPDO2 is deactivated by default (valid Bit of COB-ID set). The default mapping is shown in Table 21.

Data part of the CAN Frame of the TPDO2							
Byte0	Byte1	Byte2	Byte3	Byte4	Byte5	Byte6	Byte7
Euler angle Pitch (OV: 3100h:00h)		Euler angle Roll (OV: 3100h:01h)		unused			

Table 21: TPDO2 Default mapping Type: IS1BP360-O-DL, IS2BP090-O-DL

The following objects can be mapped to the TPDOs:

Index	Subindex	Size	Description	Format
0x3100	1	16	Euler angle: Pitch	signed, 0,01°/bit
0x3100	2	16	Euler angle: Roll	signed, 0,01°/bit
0x3101	1	16	Quaternion: w	signed, 1/30000 / bit
0x3101	2	16	Quaternion: x	signed, 1/30000 / bit
0x3101	3	16	Quaternion: y	signed, 1/30000 / bit
0x3101	4	16	Quaternion: z	signed, 1/30000 / bit
0x3102	1	16	Acceleration, x axis	signed, 1/4096g / bit
0x3102	2	16	Acceleration, y axis	signed, 1/4096g / bit
0x3102	3	16	Acceleration, z axis	signed, 1/4096g / bit
0x3103	1	16	Angular rate, x axis	signed, 7/800°/s / bit
0x3103	2	16	Angular rate, y axis	signed, 7/800°/s / bit
0x3103	3	16	Angular rate, z axis	signed, 7/800°/s / bit
0x6010	0	16	Slope Long16	signed, 0,01°/bit
0x6020	0	16	Slope Lateral16	signed, 0,01°/bit
0x6511	0	8	Device Temperature	signed, 1K/bit

Table 22: Mappable objects

8.6.1 PDO Communication Types

8.6.1.1 Individual Request (Polling)

The TPDO1 and TPDO2 (when activated) can be requested at any time by transmitting a remote-transmit request message (RTR) frame.

8.6.1.2 Cyclic Transmission

The cyclic transmission of the TPDO1 is activated if the entry 1800h/05h (interval time in milliseconds) contains a value greater than 0. Furthermore, the entry 1800h/02h (transmission type) must contain the value 254 (asynchronous, manufacturer-specific). In this case, the inclination sensor will transmit the TPDO1 cyclically at the set period interval when in the OPERATIONAL state.

The cyclic transmission of the TPDO2 is activated if the entry 1801h/05h (interval time in milliseconds) contains a value greater than 0. Furthermore, the entry 1801h/01h (transmission type) must contain the value 254 (asynchronous, manufacturer-specific). In this case, the inclination sensor will transmit the TPDO2 cyclically at the set period interval when in the OPERATIONAL state.

8.6.1.3 Synchronous Transmission

The synchronous transmission is used to get inclination values from more than one sensor at the same time. Therefore CANopen provides a SYNC object - a CAN message without user data - transmitted with high priority on the bus. This SYNC object is transmitted from a bus node (usually the master) cyclically at fixed intervals. All inclination sensors read their current value after every n^{th} reception of the SYNC object and then transmit the TPDO directly as soon as the bus permits. For this the entry 1800h/02h (transfer type) for TPDO1 or 1801h/02h for TPDO2 respectively must contain the value $n = 1 \dots 240$.

8.6.1.4 Event-controlled transmission on inclination change (manufacturer specific)

The bus load from PDOs can be reduced if the TPDO1 is only transmitted when an appropriate angle change has occurred. This function can only be configured in the manufacturer-specific part of the object directory under index 3001h. To this end, the entry 1800h/02h (transmission type) must contain the value 254 (asynchronous, manufacturer-specific). The event controlled transmission on inclination change can be activated for TPDO1 only.

8.7 Service Data: SDO

The parameters, listed in the object dictionary, are read and written through Service Data Objects (SDOs). As shown in Table 18, every object can directly be addressed over a 16-bit index. In addition, each index has an 8-bit subindex that allows an additional choice within an index. The 8 bytes of the SDOs are placed in the data area of the CAN message.

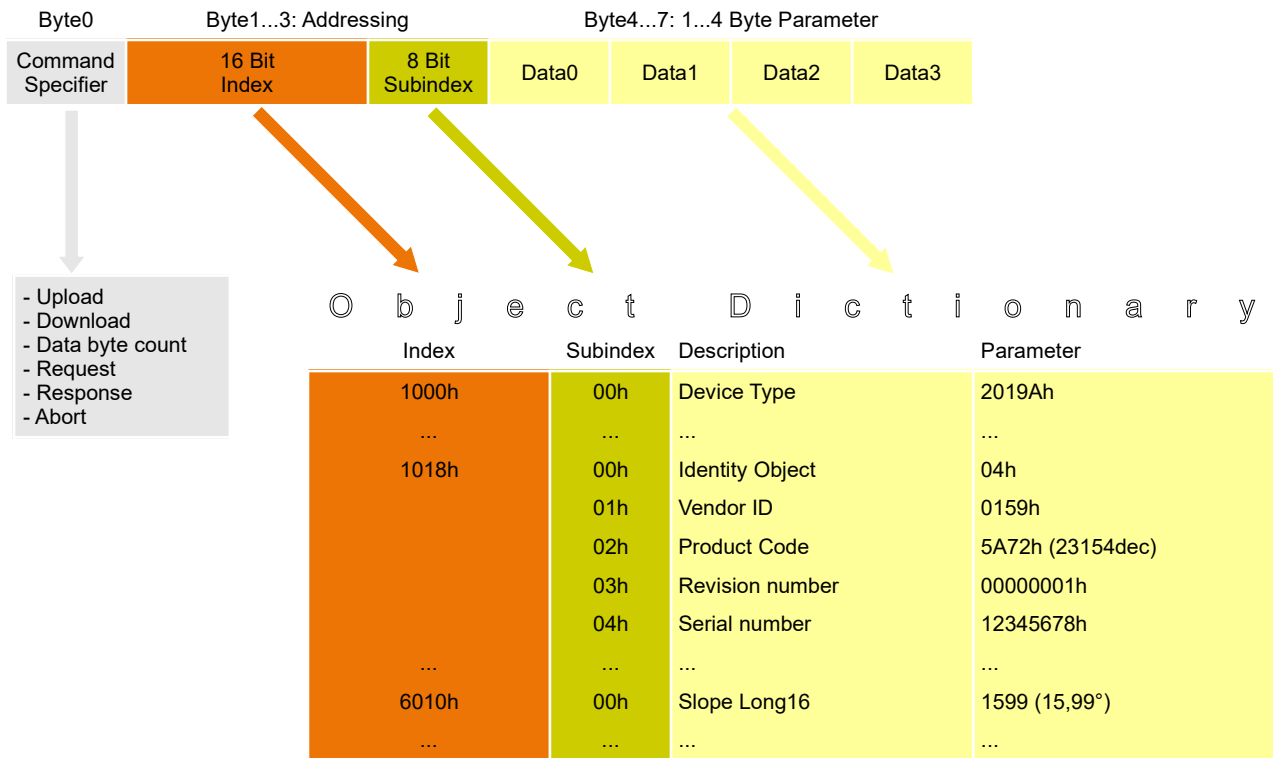

Figure 10: SDO Protocol – Access to Object Dictionary

8.8 Object Dictionary

The object directory contains all data objects that are accessible from the outside and affect the behavior of communication, application and status machines. It is divided into three parts:

- Communication specific Part (Index: 0x1000 – 0x1FFF)
- Manufacturer specific Part (Index: 0x2000 – 0x5FFF)
- Profile specific Part (Index: 0x6000 – 0x9FFF)

All parameters in the object dictionary can be read and written using the standard SDO via index and sub-index.

The following sections describe all the parameters in the object dictionary of the inclination sensor with index, subindex, data type, access rights and default (factory setting). The column "Save" indicates whether a parameter in the internal volatile memory ("save" signature in OD-Write Index 1010h/01h) can be saved.

8.8.1 Communication Parameters (according to CiA DS-301)

Index	Sub-Index	Parameter	Data Type	Access	Default Value	Save
1000h	0	Device Type (Device profile 410), Type IS1xx360-O-x(-10) / IS2xx090-O-xx(-10)	UNS32	const	1019Ah/2019Ah	
1001h	0	Error Register	UNS8	ro	0	
1002h	0	Manufacturer Status Register	UNS32	ro	0	
1003h	Pre-defined Error Field					
	0	Number of Errors entries	UNS32	rw	0	
	1..5	Error Code (oldest error on highest index)	UNS32	ro	0	
1005h	0	COB-ID Sync Message	UNS32	rw	80h	
1008h	0	Manufacturer Device Name	VSTR	const	{dep. on type}	
100Ah	0	Manufacturer Software Version („Vxx.yy“)	VSTR	const	{dep. on type}	
100Ch	0	Guard Time (Multiple of 1 ms)	UNS16	rw	0	x
100Dh	0	Life Time Factor	UNS8	rw	0	x
1010h	Store Parameters (Signature: 's','a','v','e' - 65766173h at SubIndex 1...4)					
	0	Largest supported SubIndex	UNS32	ro	4	
	1	Save all Parameters (OV: 0x1000-0x9FFF)	UNS32	rw	1	
	2	Save Communication Parameters (OV: 0x1000-0x1FFF)	UNS32	rw	1	
	3	Save Application Parameters (OV: 0x6000-0x9FFF)	UNS32	rw	1	
	4	Save Manufacturer Parameters (OV: 0x2000-0x5FFF)	UNS32	rw	1	
1011h	Restore Default Parameters (Signature: 'l','o','a','d' - 64616F6Ch at SubIndex 1...4)					
	0	Largest supported SubIndex	UNS32	ro	4	
	1	Restore all Default Parameters (OV: 0x1000-0x9FFF)	UNS32	rw	1	
	2	Restore Communication Default Parameters (OV: 0x1000-0x1FFF)	UNS32	rw	1	
	3	Restore Application Default Parameters (OV: 0x6000-0x9FFF)	UNS32	rw	1	
	4	Restore Manufacturer Default Parameters (OV: 0x2000-0x5FFF)	UNS32	rw	1	
1014h	0	COB-ID Emergency Message	UNS32	ro	80h + Node-ID	
1015h	0	Inhibit Time Emergency (multiple of 100 µs)	UNS16	rw	0	x
1017h	0	Producer Heartbeat Time (multiple of 1 ms, 0 inactive)	UNS16	rw	0	x
1018h	Identity Object					
	0	Largest supported SubIndex	UNS8	ro	4	
	1	Vendor-ID (Manufacturer ID: GEMAC Chemnitz GmbH)	UNS32	ro	159h	
	2	Product Code	UNS32	ro	{dep. on type}	
	3	Revision number	UNS32	ro	{dep. on type}	
	4	Serial number	UNS32	ro	{dep. on type}	
1200h	Server SDO1 Parameter					
	0	Largest supported SubIndex	UNS8	ro	2	
	1	COB-ID Client > Server	UNS32	ro	600h + Node-ID	
	2	COB-ID Server > Client	UNS32	ro	580h + Node-ID	
1800h	Transmit PDO1 Communication Parameter					
	0	Largest supported SubIndex	UNS8	ro	5	
	1	COB-ID	UNS32	ro*	180h + Node-ID	x*
	2	Transmission Type (synchronous / asynchronous manufacturer specific)	UNS8	rw	1	x
	3	Inhibit Time between two TPDO Messages (multiple of 100 µs)	UNS16	rw	0	x
	4	Compatibility Entry	UNS8	rw	0	x

	5	Event Timer (Multiple of 1 ms, 0 inactive)	UNS16	rw	0	x
1801h	Transmit PDO2 Communication Parameter					
	0	Largest supported SubIndex	UNS8	ro	5	
	1	COB-ID	UNS32	ro*	280h + Node-ID	x*
	2	Transmission Type (synchronous / asynchronous manufacturer specific)	UNS8	rw	1	x
	3	Inhibit Time between two TPDO Messages (multiple of 100 µs)	UNS16	rw	0	x
	4	Compatibility Entry	UNS8	rw	0	x
	5	Event Timer (Multiple of 1 ms, 0 inactive)	UNS16	rw	0	x
1A00h	Transmit PDO1 Mapping Parameter					
	0	Largest supported SubIndex	UNS8	ro	{typabh.}	
	1	Mapping Entry 1, both types: IS1BP360-O-DL, IS2BP090-O-DL	UNS32	rw	0x60100010	x
	2	Mapping Entry 2, Type: IS1BP360-O-DL / IS2BP090-O-DL	UNS32	rw	0 / 0x60200010	x
	3	Mapping Entry 3	UNS32	rw	0	x
	4	Mapping Entry 4	UNS32	rw	0	x
	5	Mapping Entry 5	UNS32	rw	0	x
	6	Mapping Entry 6	UNS32	rw	0	x
	7	Mapping Entry 7	UNS32	rw	0	x
	8	Mapping Entry 8	UNS32	rw	0	x
1A01h	Transmit PDO2 Mapping Parameter					
	0	Largest supported SubIndex	UNS8	ro	2	
	1	Mapping Entry 1	UNS32	rw	0x31000110	x
	2	Mapping Entry 2	UNS32	rw	0x31000210	x
	3	Mapping Entry 3	UNS32	rw	0	x
	4	Mapping Entry 4	UNS32	rw	0	x
	5	Mapping Entry 5	UNS32	rw	0	x
	6	Mapping Entry 6	UNS32	rw	0	x
	7	Mapping Entry 7	UNS32	rw	0	x
	8	Mapping Entry 8	UNS32	rw	0	x
1F51h	Download Program Control					
	0	Largest supported SubIndex	UNS8	ro	1	
	1	Area Firmware	UNS8	rw	1	

* The valid Bit (Bit 31) of COB-ID is saved

Table 23: Communication Parameters in the Object Dictionary

8.8.1.1 Error Register (1001h)

The error register displays the general error state of the device. Each bit stands for an error group. If one bit is set (= 1), at least one error of that specific group occurred. The content of this register is transmitted in each EMCY object. The following error groups may occur:

Error Register (1001h)							
Bit7	Bit6	Bit5	Bit4	Bit3	Bit2	Bit1	Bit0
Manufacturer Specific Error	Accuracy Warning	Profile Specific Error	Communication Error	Unused			At least one active fault

Table 24: Error Register (1001h)

If the device is in error state (at least one active error) this is shown by the set Bit0 (= 1). In case of a communication error (overflow of the transmit / receive buffers, guarding errors or CAN controller in passive

mode / Bus-Off) the Bit4 is set. A device profile specific error (sensor error) is shown by Bit5. The Bit7 indicates a vendor-specific error (EEPROM error).

8.8.1.2 Manufacturer Status Register (1002h)

This Register shows the recent state of all detectable errors. Here each bit represents a specific error. If a bit is set (= 1), this error is active at that moment. The lower 16 bits of this register (Bit15...Bit0) are transmitted in the first two bytes of the manufacturer specific part of each EMCY object and are also registered in the additional information field (Bit31-Bit16) of the Pre-defined Error Field 1003h. The definitions of the individual bits in the bit fields "Device Error" and "Communication Error" are shown in Table 35.

Manufacturer Status Register (1002h)		
Bit31...Bit16	Bit15...Bit8	Bit7...Bit0
Unused	Bit field Communication Error	Bit field Device Error

Table 25: Manufacturer Status Register (1002h)

8.8.1.3 Pre-defined Error Field (1003h)

Each inclination sensor has an error list holding the last five errors. The entry 1003h/00h contains the number of error entries in the error field. The other subindices contain all occurred error states in chronological order. The last error occurred is always located at SubIndex 01h. The oldest error can be found in the largest available SubIndex (value of 1003h/00h) and will be the first to be deleted from the list with occurrence of more than five errors. If a new error occurs a new error entry is added in 1003h and the master is notified by an EMCY object. An error entry is structured as follows:

Error Entry in Pre-defined Error Field (1003h)		
Additional Information Field (Bit31...Bit16)		Error Code (Bit15...Bit0)
Bit15...Bit0 of the manufacturer status register 1002h (at the moment of error occurrence)		0x0000 Error reset or no error present
		0x5010 Sensor Error / Sensor Error X
		0x5020 Sensor Error Y
		0x8110 Overflow of the transmit / receive buffers
		0x8120 CAN Warning Limit reached
Bit field Communication error	Bit field Device Error	0x8130 Node Guard Event
		0x8140 Recovered from Bus-Off

Table 26: Error Entry in Pre-defined Error Field (1003h)

The error list can be reset completely by writing 0 to entry 1003h/00h.

8.8.1.4 Saving (1010h) and Loading (1011h) of Parameters

If parameters are changed in the object dictionary those changes will take effect immediately. To ensure the changed parameters are still active after Reset they have to be saved in the internal EEPROM. By writing the signature „save“ (65766173h) to the entry 1010h/01h all the current parameters of the object dictionary will be saved in the internal permanent memory.

The object dictionary can be reset to its default settings by writing the signature „load“ (64616F6Ch) into the entry 1011h/01h. By doing this the factory parameters are written in the permanent memory. After a „Reset Application“ (NMT command) or a hardware reset the changes will take effect (a „Reset Communication“ (NMT command) effects the communication parameters only).

By writing the signature on SubIndex: 02h, 03h or 04h, it is possible to store or load only parts of the object directory.

8.8.1.5 Transmit PDO – Transmission Type (1800h / 1801h)

Triggering of the PDO transmissions can be defined by the entry 1800h/02h or 1801/02h respectively.

Transmit PDO - Transmission Type	
Transmission Type	Description
1...240	Synchronous (cyclic) Transmission after each 1...240 reception of a SYNC message only „Synchronized Transmission“ via SYNC possible
253	Transmission with RTR only
254	Asynchronous, manufacturer-specific „Cyclic Transmission“ and/or „Transmission on Inclination Change“ (TPDO1 only) activated by appropriate configuration

Table 27: Transmit PDO - Transmission Type

8.8.2 Manufacturer Specific Part

Index	SubIndex	Parameter	Data type	Access	Default value	Save
2002h	0	Automatic Bus-Off Recovery	BOOL	rw	0	x
3000h	Digital Filter Settings					
	0	Largest supported SubIndex	UNS8	ro	2	
	1	Filter type (0=aus, 1=Butterworth, 2=critical damped)	UNS16	rw	2	x
	2	Cut-off frequency digital filter (100...25000/8000, in mHz)	UNS16	rw	2000	x
3001h	TPDO1 Transmission on Inclination Change, type IS1BP360-O-DL					
	0	Largest supported SubIndex	UNS8	ro	2	
	1	Enable/Disable (1/0) transmission on inclination change	UNS16	rw	0	x
	2	Minimum inclination change for axial axis (multiple of °/100)	UNS16	rw	100	x
3001h	TPDO1 Transmission on Inclination Change, type IS2BP090-O-DL					
	0	Largest supported SubIndex	UNS8	ro	3	
	1	Enable/Disable (1/0) transmission on inclination change	UNS16	rw	0	x
	2	Minimum inclination change for longitudinal (X) axis (multiple of °/100)	UNS16	rw	100	x
	3	Minimum inclination change for lateral (Y) axis (multiple of °/100)	UNS16	rw	100	x
3002h	Sensor fusion configuration					
	0	Largest supported SubIndex	UNS8	ro	2	
	1	Enable/Disable (1/0) sensor fusion algorithm	UNS8	rw	1	x
	2	Maximum time of disturbance suppression (in ms)	UNS16	rw	5000	x
3100h	Euler angle output					
	0	Largest supported SubIndex	UNS8	ro	2	
	1	Euler angle Pitch (in °/100)	INT16	ro	-	
	2	Euler angle Roll (in °/100)	INT16	ro	-	
3101h	Quaternion output					
	0	Largest supported SubIndex	UNS8	ro	4	
	1	Quaternion scalar part w (in 1/30000)	INT16	ro	-	
	2	Quaternion vector part x (in 1/30000)	INT16	ro	-	
	3	Quaternion vector part y (in 1/30000)	INT16	ro	-	
	4	Quaternion vector part z (in 1/30000)	INT16	ro	-	
3102h	Raw data output acceleration sensor					
	0	Largest supported SubIndex	UNS8	ro	3	
	1	Acceleration X axis (in 1/4096 g)	INT16	ro	-	
	2	Acceleration Y axis (in 1/4096 g)	INT16	ro	-	
	3	Acceleration Z axis (in 1/4096 g)	INT16	ro	-	
3103h	Raw data output angular rate sensor					
	0	Largest supported SubIndex	UNS8	ro	3	
	1	Angular rate X axis (in 7/800 °/s)	INT16	ro	-	
	2	Angular rate X axis (in 7/800 °/s)	INT16	ro	-	
	3	Angular rate X axis (in 7/800 °/s)	INT16	ro	-	
4000h	0	Bootloader control	UNS32	w	-	
5555h	Reserved index (access for manufacturer only)					

Table 28: Manufacturer Specific Part of the Object Dictionary

8.8.2.1 Automatic Bus-Off Recovery (2002h)

This property determines the behavior of the inclination sensor when it is in the state Bus-Off. If enabled, the sensor, which is in Bus-Off state may become error-active (no longer Bus-Off) with its error counters both set to zero after having monitored 128 occurrences of 11 consecutive recessive bits on the bus.

If disabled, the inclination sensor remains in Bus-Off state.

8.8.2.2 Digital Filter Settings (3000h)

Through the entry 3000h/02h the filter type will be selected. The cut-off frequency is programmable through the object 3000h/02. Values for the cut-off frequency are allowed between 100 (= 0.1 Hz) and 25000/8000 (= 25 Hz/8 Hz). A description of the digital filter can be found in section 6.1 "Digital Filter".

Filter	Filter type (3000h/01h)	Adjustable frequency range (3000h/02h)	Applications
deactivated	0	-	statische Neigungsmessung bei Anwendungen ohne äußere Krafteinwirkungen
Butterworth	1	0.1 Hz ... 25 Hz	Static inclination measurement with high damping to vibration
Critically damped	2	0.1 Hz ... 8 Hz	Inclination measurement in applications that requires a certain dynamism, without overshoot at angle changes with good damping

Table 29: Filter selection

8.8.2.3 TPDO1 Transmission on Inclination Change (3001h)

Through the entry 3001h/01h the event controlled transmission of the TPDO1 on inclination change can be enabled (= 1) or disabled (= 0). For the activation the transmission type of TPDO1 must be set to "Asynchronous, manufacturer-specific" (1800h/02h = 254).

SubIndices 02h and 03h offer the separated setting of the minimum necessary inclination change for the longitudinal (X) and lateral (Y) axis. These two angle values are mentioned in °/100 (100fold angle value) and can be set freely from 1 = 0.01° to maximum.

If this function is enabled the inclination sensor outputs the TPDO1 object in the state OPERATIONAL in case of inclination changes of the longitudinal and/or the lateral axis greater than set under 3001h/02h and 03h. During operation the angle difference between the recent inclination value and the last one sent by the TPDO1 is permanently calculated and checked. With each change to the state OPERATIONAL the inclination sensor posts the recent position by the TPDO1 object, too (only if 3001h/01h = 1).

Remarks:

If small inclination differences are set under 3001h/02h and 03h it is recommended to enable the digital filter (index 3000h) to reduce the influence of vibrations and the frequent output of the TPDO1.

8.8.3 Device Profile Specific Part (according to CiA DS-410)

Index	Sub-Index	Parameter	Data type	Access	Default value	Save
6000h	0	Resolution (multiple of 0,001°)	UNS16	ro	10	
6010h	0	Inclination value longitudinal (X-axis, 100fold angle value in °)	INT16	ro	-	
6011h	0	Operating Parameter longitudinal (Inversion, Zero Point Adjustment)	UNS8	rw	0	x
6012h	0	Preset Value longitudinal (X) Axis	INT16	rw	0	x
6013h	0	Offset Value longitudinal (X) Axis	INT16	rw	0	x
6014h	0	Differential Offset Value longitudinal (X) Axis	INT16	rw	0	x
6020h	0	Inclination value lateral (X-axis, 100fold angle value in °)	INT16	ro	-	
6021h	0	Operating Parameter lateral (Inversion, Zero Point Adjustment)	UNS8	rw	0	x
6022h	0	Preset Value longitudinal (Y) Axis	INT16	rw	0	x
6023h	0	Offset Value longitudinal (Y) Axis	INT16	rw	0	x
6024h	0	Differential Offset Value longitudinal (Y) Axis	INT16	rw	0	x
6511h	0	Temperature (internal ind °C)	INT8	ro	-	

Table 30: Device Profile Specific Part of the Object Dictionary

8.8.3.1 Resolution (6000h)

The resolution of all inclination sensors is constantly set to 0.01° (default: 10 * 0.001°). All angle values in the object dictionary (6010h, 6012h, 6013h, 6014h and 6020h, 6022h, 6023h, 6024h) are to be interpreted as a multiple of 0.01°.

Example:

Inclination value = -2370 x 0.01° → -23.70°

8.8.3.2 Inclination values longitudinal and lateral (6010h and 6020h)

The recent inclination values of the inclination axis are accessible by SDO access to the object dictionary (in each device state) as well as by TPDO. If Zero Point Adjustment is enabled via the operating parameters 6011h and 6021h, the inclination value is calculated as follows:

$$\text{Inclination Value} = \text{Physically Measured Inclination Value} + \text{Diff. Offset Value} + \text{Offset Value}$$

On disabled Zero Point Adjustment:

$$\text{Inclination Value} = \text{Physically Measured Inclination Value}$$

Example:

Value Range Type IS1BP360-O-DL: -18000 ... +17999 → -180,00° ... +179,99° = 0 ...359,99°

Value Range Type IS2BP090-O-DL: -9000 ... +9000 → - 90,00° ... + 90,00°

8.8.3.3 Operating Parameters (6011h and 6021h)

The operating parameters settings of an inclination sensor (6011h and 6021h) allow the changing of the mathematical sign of the inclination value and a Zero Point Adjustment. On Factory Default Settings, these options are disabled, i.e. the direction of the inclination value (polarity of the axis) corresponds to the one shown on the nameplate of the inclination sensor.

Operating Parameters (6011h and 6021h)							
Bit7	Bit6	Bit5	Bit4	Bit3	Bit2	Bit1	Bit0
Unused						Zero Point Adjustment 0 = /inactive 1 = active	Inversion 0 = /inactive 1 = active

Table 31: Operating Parameters (6011h and 6021h)

8.8.3.4 Zero Point Adjustment: Preset Value, Offset Value, Differential Offset Value (60x1/2/3h)

Using the values “Preset Value”, “Offset Value” and “Differential Offset Value” the adjustment of the Zero Point is possible. The Zero Point Adjustment is only active if the Bit1 in the operating parameters (6011h/6021h) is set.

Value	Object	Description
Preset Value	6012h 6022h	Preset Value for Zero Point Adjustment, value range depends on settings in object 6000h
Offset Value	6013h 6023h	Calculated Offset Value when writing to object 6012h or 6021 Calculated Offset Value = Preset Value at tacc – physically measured Inclination Value at tacc – Differential Offset Value tacc: time when accessing object (6012h,6022h)
Differential Offset Value	6014h 6024h	Additional Offset, regardless of object 6012h and 6013h / 6022h and 6023h The value you enter here will be added up directly to the inclination value.

Table 32: Zero Point Adjustment

8.9 Emergency Objects

Each inclination sensor supports EMCY objects which are transmitted in case of sensor and hardware errors. If such an error occurs the OD entries 1001h (Error Register), 1002h (Manufacturer Status Register) and 1003h (Pre-defined Error Field) are updated. After abolishment of an error, the device transmits an emergency message with the Error Reset Code 0x0000. Remaining errors are signaled in Byte2 (Error Register) and Bytes 3,4 in the Manufacturer specific error field. Once the device is error-free, it sends an emergency message which contains only zeros. The current state of the device (Pre-Operational, Operational or Stopped) is not influenced by the error states, except in case of a guarding error.

Emergency messages are sent with high priority on the bus and are always 8 bytes long. The structure of the telegram is shown in Table 33:

Emergency Object							
Byte0	Byte1	Byte2	Byte3	Byte4	Byte5	Byte6	Byte7
Emergency Error Code		Error Register (1001h)	Manufacturer Specific Error Field				
			Bit field Communication Error	Bit field Device Error	0x00	0x00	0x00

Table 33: Emergency Object

Emergency Error Codes	
0x0000	Error Reset or no Error (Error Register = 0)
0x5010	Sensor Error / Sensor Error X, Inclination value out of range
0x5020	Sensor Error Y, Inclination value out of range
0x5040	Accuracy warning, acceleration or angular rate values are out of range, inclination accuracy of the sensor is limited
0x8110	Overflow of the transmit / receive buffers, CAN messages were lost
0x8120	CAN Warning Limit reached
0x8130	Node Guard Event (The loss of the Guarding-Master has been detected)
0x8140	Recovered from Bus-Off

Table 34: Emergency Error Code

Bit field Device Errors		
0x01	Sensor Error	type only: IS1xx360-O-xL(-10)
0x01	Sensor Error X-Axis	type only: IS2xx090-O-xL(-10)
0x02	Sensor Error Y- Axis	type only: IS2xx090-O-xL(-10)
0x80	EEPROM Error: An error occurred while saving the configuration.	
Bit field Communication Errors		
0x01	CAN Warning Limit reached (too many Error Frames)	
0x02	CAN Bus-Off State reached (An Emergency message will be transmitted after the device has recovered from Bus-Off)	
0x04	Receive Queue Overrun,	CAN messages were lost
0x08	Transmit Queue Overrun,	CAN messages were lost
0x80	Guarding Error,	The loss of the Guarding-Master has been detected. (Node Guard Event)

Table 35: Emergency: Manufacturer Specific Error Field

8.10 Failure monitoring

Since the nodes do not respond at regular intervals with the event-controlled transmission in a CANopen network, Heartbeat and Nodeguarding / Lifeguarding failure monitoring mechanisms are provided. Only one of the two monitoring methods can be active.

8.10.1 Nodeguarding / Lifeguarding

Nodeguarding is the monitoring of one or several nodes by the NMT master. The NMT master periodically sends a RTR message frame to the slave to be monitored, which responds with its status and a toggle bit. If the status or the toggle bit do not comply with the status or toggle bit expected by the guarding master or if no response is provided, the master assumes a slave error.

The node to be monitored may also use this mechanism to detect a failure of the guarding master. Therefore two parameters are used. The interval time after which the guarding master polls the inclination sensor to be monitored is the Guard Time (100Ch). Another parameter, the Life Time Factor (100Dh), defines a multiplier after which the connection is deemed to be interrupted. This time is designated as the node life time.

$$\text{„Node Life Time“} = \text{„Guard Time“} \times \text{„Life Time Factor“}$$

If the inclination sensor does not receive a guarding request from the master within the parametrized time, it also assumes a master failure, sends an emergency message frame and returns to the "Pre-Operational" state. If either of the two parameters is "0" (default setting), the master is not monitored (no Lifeguarding).

8.10.2 Heartbeat

Heartbeat is a failure monitoring mechanism which can operate without using RTR message frames. In this case, the inclination sensor cyclically transmits a heartbeat message which contains the state of the device. The master can monitor these message frames. Heartbeat is activated once a value greater than "0" is entered in the heartbeat interval time register (1017h).

Remarks:

Heartbeat has a significant influence on the bus load of the CANopen network, but produces only half the bus load of Nodeguarding / Lifeguarding.

8.11 LSS: Layer Setting Service (according to CiA DSP-305)

8.11.1 Setting of Node-ID and Baud Rate

The setting of the node address (Node-ID) and the Baud Rate is realized by LSS (Layer Setting Service). For communication between LSS Master and LSS Slave (inclination sensor) two CAN identifiers (7E5h and 7E4h) are used. Each inclination sensor has a unique 128-bit LSS address, at which it can be addressed in the CAN network. This address is composed of the three 32-bit parameters of the Identity object 1018h and the serial number:

Vendor-ID	0000 0159h	(Manufacturer ID: GEMAC Chemnitz GmbH)
Product Code	0000 662Ah	(662Ah = 26154dec = PR- 26154-30)
Revision Number	0000 001Eh	(1Eh = 30dec = PR- 26154-30)
Serial Number	xxxx xxxxh	(serial number of the incl. sensor → nameplate)

The default values for Node-ID and Baud Rate at delivery (factory settings) are:

Node-ID	10
Baud Rate	Automatic Baud Rate Detection

Index	Baud Rate
0	1 MBit/s
1	800 kBit/s
2	500 kBit/s
3	250 kBit/s
4	125 kBit/s
5	reserved
6	50 kBit/s
7	20 kBit/s
8	10 kBit/s
9	Automatic Baud Rate Detection

Table 36: LSS Baud Rate Index according to CiA DSP-305

8.12 Automatic Baud Rate Detection (according to CiA AN-801)









The automatic baud rate detection is used to automatically adjust the baud rate of the inclination sensor on the existing baud rate in the network. After power-on the inclination sensor only listens to the CAN network without acknowledging the received messages on the bus. This operating condition is characterized by the flickering RUN-LED (see also section 8.13 “Status LED (according to CiA DR-303-3)”). The sensor checks all the available baud rates. Upon reception of a valid CAN telegram, the correct baud rate is adjusted. Then the sensor starts up, sends its boot-up message and enters the Pre-Operational state. (see also 9).

Remarks:

For proper operation of the automatic baud rate detection it is necessary to receive messages from other can nodes on the bus.

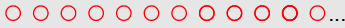
8.13 Status LED (according to CiA DR-303-3)

The integrated two-color Status LED signals the recent device state (Run LED, green) as well as CAN communication errors that might have occurred (Error LED, red). The color and the flashing frequency of the LED distinguish the different device states as shown in Table 37.

Status LED		
RUN LED	LED State	Description
	Off	The device is in state Reset or no power supply is connected
	Flickering	Automatic baud rate detection is currently running (active)
	Blinking	The device is in state Pre-Operational
	Single Flash	The device is in state Stopped
	On	The device is in state Operational
ERROR LED	LED State	Description
	Off	The device is in working condition
	Single Flash	CAN Warning Limit reached
	Double Flash	The loss of the Guarding-Master has been detected. (Node Guard Event)
	On	The device is in state Bus-Off





Legend:  LED off  LED on  LED flickering (50 ms on/off) Duration of /: 200 ms

Table 37: Status and Error Display of the Two-Color LED

9 Functional Description J1939 Interface

9.1 Message format

J1939 uses extended identifiers (29 bit) for CAN-bus communication. Both, Broadcast messages, that are sent to all nodes on the bus using PDU format 2, and PDU format 1 telegrams, with direct addressing for communication between two nodes, are supported by the device.

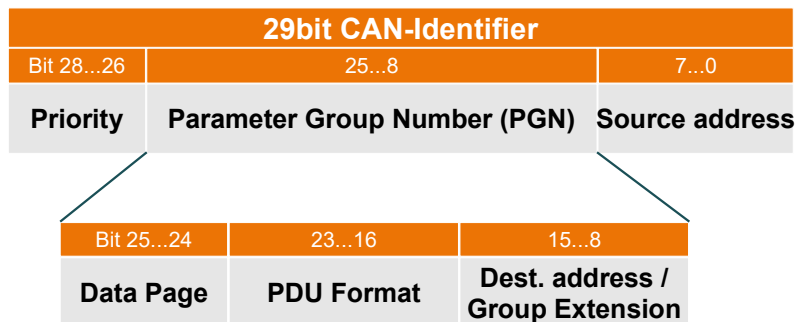

Figure 11: J1939 CAN-Identifier

Point-to-point messages are sent with a PDU format value of 00h to EFh and a specific destination address. Broadcast messages contain the PDU format values F0h to FFh. The field group extension increases the number of available broadcast messages.

The inclination sensor supports broadcast messaging with PDU format 2 for sending process data like angle values or raw sensor data (see section 9.3 „Process data (Transmit PGNs)“). For configuration of the sensor, direct addressing with PDU format 1 and proprietary A PGN is used (see section 9.4 „Sensor configuration“).

9.2 Device name and address

With factory default setting, the sensor starts with a device address of 128 (80h). Dynamic addressing is supported. After power-on, the sensor transmits an address-claim message containing the used address and the 64 bit device name, which identifies the sensor uniquely on the bus. The device name also defines the priority of the sensor in the network.

The 64 bit device name contains the following fields:

- Arbitrary Address Capable, support of dynamic addressing (1 bit)
- Industry Group (3 bit)
- Vehicle System Instance (4 bit)
- Vehicle System (7 bit)
- Function (8 bit)
- Function Instance (5 bit)
- ECU Instance (3 bit)
- Manufacturer Code (11 bit)
- Identity Number (21 bit)

The Manufacturer Code is the identifier of GEMAC Chemnitz GmbH (value 854 decimal). The Identity Number is the J1939 serial number of the sensor.

The following fields are set to fixed factory settings:

- Manufacturer Code: 854 (GEMAC Chemnitz GmbH)
- Identity Number: J1939 unique serial number of the sensor
- Industry Group: 0
- Vehicle System: 0
- Function: 145 (Inertial Sensor)

All other fields of the device name can be changed by the user by configuration messages (see section 9.4 „Sensor configuration“).

9.3 Process data (Transmit PGNs)

For sending of measurement values, the sensor supports the standardized PGNs 61459 (Slope Sensor Information) and 61481 (Slope Sensor Information 2) as well as PGN 61482 (Angular Rate Information) and PGN 61485 (Acceleration Sensor). Additionally, Proprietary B messages (broadcast) are supported.

The following transmit PGNs are available:

- TxPGN1 61459 Slope Sensor Information
- TxPGN2 61481 Slope Sensor Information 2 (extended range)
- TxPGN3 61482 Angular Rate Information
- TxPGN4 61485 Acceleration Sensor
- Proprietary B TxPGN5 65280 inclination value longitudinal, lateral or inclination value axial (z-axis)
- Proprietary B TxPGN6 65281 Euler angles pitch and roll
- Proprietary B TxPGN7 65282 Quaternion
- Proprietary B TxPGN8 65283 acceleration sensor raw data x-, y- and z-axis
- Proprietary B TxPGN9 65284 gyroscope raw data, turn rate x-, y- and z-axis

The PGNs can be activated or deactivated individually by configuration messages. Additionally, the cycle time and the message priority can be configured. For the proprietary B PGNs, the LSB of the PGN number also can be set by the user.

By factor default settings, the transmit PGNs 2 (Slope Sensor Information 2) and 5 (Inclination value) are enabled with a cycle time of 10 ms.

PGN	Name	SPN name	SPN position (bit)	SPN size (bit)	Resolution	Offset	Data range
61459	Slope Sensor Information	Pitch Angle	0	16	0.002 °/bit	-64°	-64...64.51°
		Roll Angle	16	16	0.002 °/bit	-64°	-64...64.51°
		Pitch Rate	32	16	0.002 °/s/bit	-64°/s	-64...64.51°/s
		Pitch Angle Figure of Merit	48	2	4 States	0	0...3
		Roll Angle Figure of Merit	50	2	4 States	0	0...3
		Pitch Rate Figure of Merit	52	2	4 States	0	0...3
		Sensor fusion status	54	2	4 States	0	0...3
		Latency	56	8	0.5 ms/bit	0	0...125 ms

Table 38: Transmit PGN 1 - 61459 Slope Sensor Information

PGN	Name	SPN name	SPN position (bit)	SPN size (bit)	Resolution	Offset	Data range
61481	Slope Sensor Information 2	Pitch Angle (ext. Range)	0	24	1/32768 °/bit	-250°	-250...252° (-90...90°)
		Roll Angle (ext. Range)	24	24	1/32768 °/bit	-250°	-250...252°
		Pitch Angle compensation	48	2	4 States	0	0...3
		Pitch Angle Figure of Merit	50	2	4 States	0	0...3
		Roll Angle compensation	52	2	4 States	0	0...3
		Roll Angle Figure of Merit	54	2	4 States	0	0...3
		Latency	56	8	0.5 ms/bit	0	0...125 ms

Table 39: Transmit PGN 2 – 61481 Slope Sensor Information 2

PGN	Name	SPN name	SPN position (bit)	SPN size (bit)	Resolution	Offset	Data range
61482	Angular Rate Information	Pitch Rate (ext. Range)	0	16	1/128 °/s/bit	-250°/s	-250...250°/s
		Roll Rate (ext. Range)	16	16	1/128 °/s/bit	-250°/s	-250...250°/s
		Yaw Rate (ext. Range)	32	16	1/128 °/s/bit	-250°/s	-250...250°/s
		Pitch Rate Figure of Merit	48	2	4 States	0	0...3
		Roll Rate Figure of Merit	50	2	4 States	0	0...3
		Yaw Rate Figure of Merit	52	2	4 States	0	0...3
		Latency	56	8	0,5 ms/bit	0	0...125 ms

Table 40: Transmit PGN 3 – 61482 Angular Rate Information

PGN	Name	SPN name	SPN position (bit)	SPN size (bit)	Resolution	Offset	Data range
61485	Acceleration Sensor	Lateral Acceleration (Y axis)	0	16	0,01 m/s ² /bit	-320m/s ²	-80...80m/s ²
		Longitudinal Accelertaion (X axis)	16	16	0,01 m/s ² /bit	-320m/s ²	-80...80m/s ²
		Vertical Acceleration (Z axis)	32	16	0,01 m/s ² /bit	-320m/s ²	-80...80m/s ²
		Lateral Acceleration Figure of Merit	48	2	4 States	0	0...3
		Longitudinal Acceleration Figure of Merit	50	2	4 States	0	0...3
		Vertical Acceleration Figure of Merit	52	2	4 States	0	0...3
		Support variable transmission repetition rate	54	2	4 States	0	0...3

Table 41: Transmit PGN 4 – 61485 Acceleration Sensor

PGN*	Name	SPN name	SPN position (bit)	SPN size (bit)	Resolution	Offset	Data range
65280	Proprietary B TxPGN3 perpendicular angle	Inclination angle longitudinal (x axis)	0	16	0.01 °/bit	0°	-90...90°
		Inclination angle lateral (y axis)	16	16	0.01 °/bit	0°	-90...90°

Table 42: Transmit PGN 5 - Inclination angle for IS2BP090-J-DL

PGN*	Name	SPN name	SPN position (bit)	SPN size (bit)	Resolution	Offset	Data range
65280	Proprietary B TxPGN3 angle	Inclination angle axial	0	16	0.01 °/bit	0°	-180...180°

Table 43: Transmit PGN 5 - Inclination angle for IS1BL360-J-DL

PGN*	Name	SPN name	SPN position (bit)	SPN size (bit)	Resolution	Offset	Data range
65281	Proprietary B TxPGN4 Euler angles	Pitch	0	16	0.01 °/bit	0°	-90...90°
		Roll	16	16	0.01 °/bit	0°	-180...180°

Table 44: Transmit PGN 6 - Euler angles

PGN*	Name	SPN name	SPN position (bit)	SPN size (bit)	Resolution	Offset	Data range
65282	Proprietary B TxPGN5 Quaternion	Quaternion scalar part w	0	16	1/30000 / bit	0	-1.0...1.0
		Quaternion vector part x	16	16	1/30000 / bit	0	-1.0...1.0
		Quaternion vector part y	32	16	1/30000 / bit	0	-1.0...1.0
		Quaternion vector part z	48	16	1/30000 / bit	0	-1.0...1.0

Table 45: Transmit PGN 7 – Quaternion

PGN*	Name	SPN name	SPN position (bit)	SPN size (bit)	Resolution	Offset	Data range
65283	Proprietary B TxPGN6 Acceleration sensor raw data	Acceleration x axis	0	16	1/4096g / bit	0	-8g...8g
		Acceleration y axis	16	16	1/4096g / bit	0	-8g...8g
		Acceleration z axis	32	16	1/4096g / bit	0	-8g...8g

Table 46: Transmit PGN 8 – Acceleration

PGN*	Name	SPN name	SPN position (bit)	SPN size (bit)	Resolution	Offset	Data range
65284	Proprietary B TxPGN7 Gyroscope sensor raw data	Angular rate x axis	0	16	7/800°/s / bit	0	-250...250°/s
		Angular rate y axis	16	16	7/800°/s / bit	0	-250...250°/s
		Angular rate z axis	32	16	7/800°/s / bit	0	-250...250°/s

Table 47: Transmit PGN 9 – Angular rate

* For proprietary B PGNs, the LSB of the PGN number can be configured by the user

9.4 Sensor configuration

For reading and writing the sensor configuration, proprietary A PGN 61184 (point-to-point messaging) is used. The data part of the telegram has the following structure:

D0	D1	D2	D3	D4	D5	D6	D7
INDEX		CMD	STATUS	DATA0	DATA1	DATA2	DATA3

INDEX Parameter index (see Table 48)
 CMD Command (0x01: read, 0x02: write)
 STATUS Status (only valid in reply from sensor, see Table 51)
 DATA0...DATA3 0 to 4 bytes of data (valid number of bytes depends on the parameter index)

Index	Parameter	Data Type	Value	Access
0x1000	Vendor-ID	UNS32	-	ro
0x1001	Product-ID	UNS32	-	ro
0x1002	Product revision	UNS32	-	ro
0x1003	Serial number	UNS32	-	ro
0x1004	Firmware version	UNS16	-	ro
0x1005	Device-ID	UNS32	-	ro
0x1100	Device status	UNS8	-	ro
0x2000	CAN baudrate	UNS16	0: Autobaud 250 (default) 10, 20, 50, 100, 125, 500, 800, 1000	rw
0x2001	Device address	UNS8	128 (default)	rw
0x2002	Automatic Bus-Off Recovery	UNS8	0 (default) inactive 1 active	rw
0x2010	Arbitrary Address Capable	UNS8	0: address claiming inactive 1 : address claiming active (default)	rw
0x2011	Industry Group	UNS8	0	ro
0x2012	Vehicle system instance	UNS8	0...15 (default: 0)	rw
0x2013	Vehicle system	UNS8	0	ro
0x2014	Function	UNS8	145	ro
0x2015	Function Instance	UNS8	0...31 (default: 0)	rw
0x2016	ECU Instance	UNS8	0...7 (default: 0)	rw
0x2100	Filter type digital filter	UNS16	0: inactive 1: Butterworth filter 2: critical damped (default)	rw
0x2101	Cut-Off-frequency digital filter	UNS16	100...25000 mHz default: 5000 mHz	rw
0x2110	Sensorfusion enable	UNS8	0: Sensorfusion deaktiviert 1: Sensorfusion aktiviert (default)	rw
0x2111	Sensor fusion suppression time	UNS16	100...10000 ms default: 5000 ms	rw
0x2120	Dynamic gyroscope offset correction	UNS8	0: inactive 1: active (default)	rw
0x2121	Run gyroscope offset correction	UNS8	Writing 1 forces the gyro offset correction and stores the offset values permanently. The calculation of the offset values takes about 2 seconds.	wo
0x2122	Dynamic gyroscope offset correction level	UNS8	Value range 1...10 (default: 3) 1: for applications with low dynamic movement 10: for application with high dynamic movement	rw
0x2200	Zero offset x axis automatically*	UNS8	Set x axis angle to zero 0: reset offset (absolute measurement) 1: zero (relative measurement)	wo
0x2201	Zero offset x axis*	INT16	Zero offset x axis	rw

Index	Parameter	Data Type	Value	Access
0x2202	Invert x axis	UNS8	0: x axis not inverted 1: x axis inverted	rw
0x2210	Zero offset y axis automatically* (only IS2BP090-J-DL)	UNS8	Set y axis angle to zero 0: reset offset (absolute measurement) 1: zero (relative measurement)	wo
0x2211	Zero offset y axis* (only IS2BP090-J-DL)	INT16	Zero offset y axis	rw
0x2212	Invert y axis (only IS2BP090-J-DL)	UNS8	0: y axis not inverted 1: y axis inverted	rw
0x2300	Store parameters	VSTR	Write 'SAVE' (45564153h) to store parameters permanently	wo
0x2301	Load parameters	VSTR	Write 'LOAD' (44414F4Ch) to load parameters from permanent memory	wo
0x2302	Reset to factory default parameters	VSTR	Write 'CLR' (524C43h) to apply factory default settings	wo
0x2303	Reset sensor	VSTR	Write 'RST' (545352h) to reset the device	wo
* zero point setting only valid for perpendicular angles (TxPGN5)				
Configuration TxPGNs				
0x3000	TxPGN1 cycle time PGN 61459 Slope Sensor Information	UNS16	0: deactivated (default) 10...10000 ms cycle time	rw
0x3001	TxPGN1 priority PGN 61459 Slope Sensor Information	UNS8	0...7 (default: 3)	rw
0x3010	TxPGN2 cycle time PGN 61481 Slope Sensor Information 2	UNS16	0: deactivated (default) 10...10000 ms cycle time	rw
0x3011	TxPGN2 priority PGN 61481 Slope Sensor Information 2	UNS8	0...7 (default: 3)	rw
0x3020	TxPGN3 cycle time PGN 61482 Angular Rate Information	UNS16	0: deactivated 10...10000 ms cycle time default: 10 ms	rw
0x3021	TxPGN3 priority PGN 61482 Angular Rate Information	UNS8	0...7 (default: 3)	rw
0x3030	TxPGN4 cycle time PGN 61485 Acceleration Sensor	UNS16	0: deactivated (default) 10...10000 ms cycle time	rw
0x3031	TxPGN4 priority PGN 61485 Acceleration Sensor	UNS8	0...7 (default: 3)	rw
0x3040	TxPGN5 cycle time PGN 65280 Perpendicular Angle	UNS16	0: deactivated (default) 10...10000 ms cycle time	rw
0x3041	TxPGN5 priority PGN 65280 Perpendicular Angle	UNS8	0...7 (default: 3)	rw
0x3042	TxPGN5 LSB PGN 65280 Perpendicular Angle	UNS8	0x00...0xFF default: 0x02	rw
0x3050	TxPGN6 cycle time PGN 65281 Euler-Angle	UNS16	0: deactivated 10...10000 ms cycle time default: 10 ms	rw
0x3051	TxPGN6 priority PGN 65281 Euler-Angle	UNS8	0...7 (default: 3)	rw
0x3052	TxPGN6 LSB PGN 65281 Euler-Angle	UNS8	0x00...0xFF default: 0x03	rw

Index	Parameter	Data Type	Value	Access
0x3060	TxPGN7 cycle time PGN 65282 Quaternion	UNS16	0: deactivated 10...10000 ms cycle time default: 10 ms	rw
0x3061	TxPGN7 priority PGN 65282 Quaternion	UNS8	0...7 (default: 3)	rw
0x3062	TxPGN7 LSB PGN 65282 Quaternion	UNS8	0x00...0xFF default: 0x04	rw
0x3070	TxPGN8 cycle time PGN 65283 Acceleration x, y, z axis	UNS8	0: deactivated 10...10000 ms cycle time default: 10 ms	rw
0x3071	TxPGN8 priority PGN 65283 Acceleration x, y, z axis	UNS8	0...7 (default: 3)	rw
0x3072	TxPGN8 LSB PGN 65283 Acceleration x, y, z axis	UNS8	0x00...0xFF default: 0x04	rw
0x3080	TxPGN9 cycle time PGN 65284 Angular Rate x, y, z axis	UNS8	0: deactivated 10...10000 ms cycle time default: 10 ms	rw
0x3081	TxPGN9 priority PGN 65284 Angular Rate x, y, z axis	UNS8	0...7 (default: 3)	rw
0x3082	TxPGN9 LSB PGN 65284 Angular Rate x, y, z axis	UNS8	0x00...0xFF default: 0x04	rw
Process data				
0x5000	Read angle values	UNS32	Angle output (according to Transmit PGN 3)	ro
0x5001	Read temperature values	INT8	Temperature in °C	ro

Table 48: Configuration parameters

The device parameters can be stored in the internal nonvolatile memory by sending the “SAVE” command (index 0x2300).

The CAN baudrate and the device address are directly written to the nonvolatile memory of the sensor. To apply the new values, a reset of the sensor is required.

9.4.1 Examples J1939 communication

	CAN-Identifier	D0	D1	D2	D3	D4	D5	D6	D7
		INDEX	CMD	STATUS	DATA0	DATA1	DATA2	DATA3	
Request	0x0CEF8001	0x04	0x10	0x01	0x00	0x00	0x00	0x00	0x00
Reply	0x0CEF0180	0x04	0x10	0x01	0x00	0x01	0x00	0x00	0x00

Table 49: Read the firmware version of the sensor (device address 128)

	CAN-Identifier	D0	D1	D2	D3	D4	D5	D6	D7
		INDEX	CMD	STATUS	DATA0	DATA1	DATA2	DATA3	
Request	0x0CEF8001	0x10	0x21	0x02	0x00	0x01	0x00	0x00	0x00
Reply	0x0CEF0180	0x10	0x21	0x02	0x00	0x01	0x00	0x00	0x00

Table 50: Activate sensor fusion (device address 128)

9.4.2 Status byte description

Value	Description
0x00	Ok, processing successfully
0xF0	invalid index
0xF1	invalid parameter, parameter out of range
0xF2	EEPROM read-/write-error

Table 51: Statusbyte

10 Service

10.1 Calibration

Every sensor is calibrated by the manufacturer GEMAC Chemnitz GmbH as standard before delivery.

Even the highest quality sensors have to be recalibrated at certain intervals in order to continue to deliver reliable, safe and error-free measurement results. We therefore recommend regular recalibration. This shall be done exclusively by the manufacturer GEMAC GmbH.

10.2 Service

10.2.1 Reshipment

Reshipment of the sensor for calibration or repairing purposes must be executed in the original packaging or an equivalent packaging. Please indicate a short error description and your phone number for further inquiries.

10.2.2 Support

Please indicate the serial number and the firmware revision of your inclination sensor for technical support.

Manufacturer: GEMAC Chemnitz GmbH

Zwickauer Str. 227

09116 Chemnitz

Germany

Phone: +49 371 3377-0

Fax: +49 371 3377-272

Web: www.gemac-chemnitz.com

Mail: info@gemac-chemnitz.de

10.2.3 Warranty and limitation of liability

We will assume a warranty of 24 months for the sensor, commencing from the date of delivery. Any repairs which are required during this time and fall under the manufacturer's obligation to give a warranty will be performed free of charge. Any damage resulting from improper use of the device or from exceeding of the specified technical parameters is not covered by the manufacturer's obligation to give a warranty.

GEMAC Chemnitz GmbH will only be liable for consequential damage resulting from use of the product in case of deliberate action or gross negligence on its own part.

The General Terms and Conditions of GEMAC Chemnitz GmbH shall apply.

11 Sensor configuration

11.1 Inclination sensor programming adapter

With the optional inclination sensor programming adapter (starter kit ISPA2 - PR-23999-10) it is possible to adjust all inclination sensors with CAN, CANopen or J1939 interface. The programming adapter is connected via USB to a PC. The connection of the sensors with the programming adapter is realized through the included CAN adapter cable. The inclination sensor is supplied with power through the adapter. No additional voltage supply is necessary.

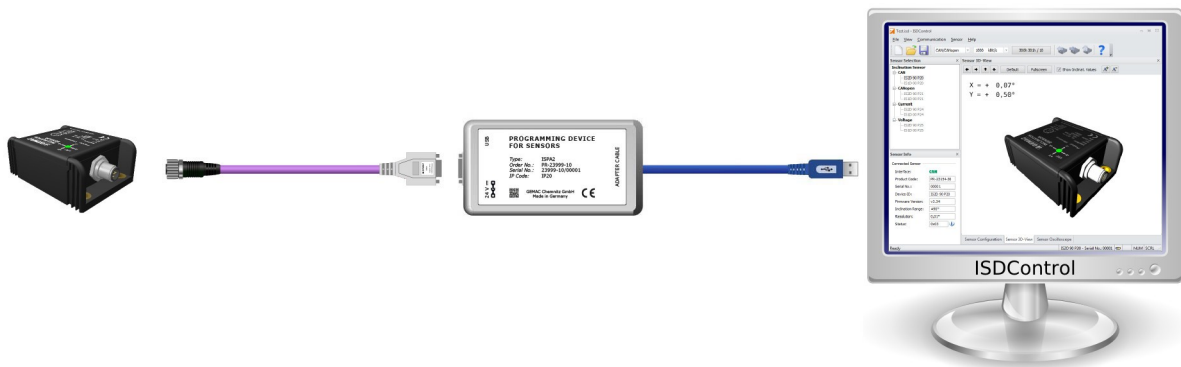

Figure 12: Starter kit

11.2 PC software ISDControl

The parametrization of all possible values is done with the PC software ISDControl, which is included in all starter kits. Each configuration can be stored in a file.

Properties:

- comfortable configuration of all parameters of the inclination sensor
- 3D imaging and display of the current angle
- Oscilloscope display of the current angle
- Firmware Download option
- Automatic inclination sensor search for unknown communication parameters



Figure 13: PC software

12 Ordering Information

Article Number	Product Type	Interface	Axes / measurement range
PR-26050-30	IS1BP360-C-DL	CAN	1-dimensional, 360°
PR-26054-30	IS2BP090-C-DL	CAN	2-dimensional, ±90°
PR-26150-30	IS1BP360-O-DL	CANopen	1-dimensional, 360°
PR-26154-30	IS2BP090-O-DL	CANopen	2-dimensional, ±90°
PR-26750-30	IS1BP360-J-DL	J1939	1-dimensional, 360°
PR-26754-30	IS2BP090-J-DL	J1939	2-dimensional, ±90°
PR-23999-10	ISPA2	Inclination sensor programming adapter (Starter kit including programming adapter, cables and PC software)	

Table 52: Ordering information