



User Manual

Inclination Switch
Programming Tool
PC-Software

PR-23666-00 ISW2SP360
PR-23997-00 ISWPA1
ISwitchControl

Version: 1.7

Date: 2017-12-06

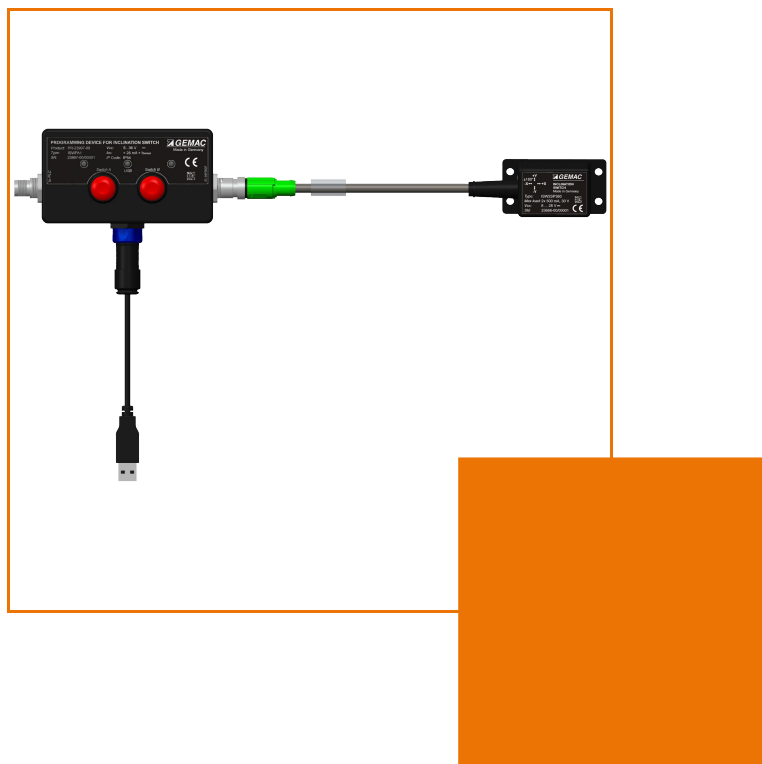

GEMAC Chemnitz GmbH
Zwickauer Straße 227
D - 09116 Chemnitz
Germany

Phone: +49 371 3377 - 0
Fax: +49 371 3377 - 272
E-Mail: info@gemac-chemnitz.de
Web: www.gemac-sensors.com

Revision History

Date	Revision	Changes
2016-09-16	1.0	First version
2016-10-17	1.1	Layout changes
2016-10-24	1.2	Linguistic corrections
2016-10-27	1.3	Switch status view in ISwitchControl added
2016-11-18	1.4	Linguistic corrections
2017-02-02	1.5	Correction of dimensional tolerance
2017-06-28	1.6	Correction Table 2
2017-12-06	1.7	Addition Table 3

© Copyright 2017 GEMAC Chemnitz GmbH

This document is subject to change without notice.

We constantly work to further develop of our products. We reserve any changes of the scope of delivery in shape, equipment and technology for ourselves. No claims can be made from the details, illustrations and descriptions in this document.

Any kind of duplication, reprocessing and translation of this document as well as excerpts from it require the written permission of GEMAC Chemnitz GmbH.

All rights according to the copyright remain explicitly reserved for GEMAC Chemnitz GmbH.

All brands and trade marks mentioned in this document are the property of their respective owners.

Table of Contents

1 Safety information.....	4
1.1 Receiving inspection.....	4
1.2 Intended use.....	4
1.3 Incorrect use.....	4
1.4 Requirements to the qualification of personnel.....	4
2 Technical Data ISW2SP360.....	5
2.1 Characteristics.....	5
2.2 Applications.....	5
2.3 Device description.....	6
2.4 Overview.....	7
2.5 Orientation of measurement axes.....	8
2.6 M12 Plug connector pin assignment.....	9
2.7 Block diagram.....	9
2.8 Mounting.....	10
2.9 Dimensioned drawing.....	10
2.10 Factory settings.....	11
2.11 Function of the LED.....	11
2.12 Special features of the inclination switch.....	11
3 Technical Data Programming Device ISWPA1.....	14
3.1 Characteristics.....	14
3.2 Device description.....	14
3.3 Overview.....	15
3.4 M12-Connector male pin assignment.....	15
3.5 M12-Connector female pin assignment.....	16
3.6 Block diagram.....	16
3.7 Function of the LEDs.....	17
4 Definition of terms.....	18
4.1 Zero-point.....	18
4.2 Hysteresis.....	18
4.3 Dead time.....	19
5 Adjustment of Switching Thresholds with the Programming Device ISWPA1.....	22
5.1 Example of adjusting switching thresholds.....	22
6 Start-up ISwitchControl.....	23
6.1 System requirements.....	23
6.2 Installation of software and driver.....	23
6.3 Connecting the inclination switch.....	23
7 ISwitchControl.....	25
7.1 General notes on operation.....	25
7.1.1 Help.....	25

7.1.2 Data saving.....	25
7.2 Program structure.....	25
7.2.1 Toolbar.....	25
7.2.2 View „Sensor Info“.....	25
7.2.3 View „Sensor Configuration All Parameters“.....	26
7.2.4 View „Sensor Configuration Graphical Input“.....	28
7.2.5 Hysteresis representation in the “Sensor Configuration Graphical Input” view.....	30
7.2.6 View „Sensor 3D-View“.....	33
7.2.7 View „Sensor Oscilloscope“.....	34
8 Maintenance and Service.....	35
8.1 Calibration.....	35
8.2 Service.....	35
8.2.1 Return.....	35
8.2.2 Support.....	35
8.2.3 Warranty and restriction of liability.....	35
9 Order information.....	36

1 Safety information

1.1 Receiving inspection

Please unpack the device carefully, immediately after reception and check the delivery for completeness and damages. In case of any suspected damages please notify the delivery service within 72 hours and keep the package for assessment. The device must only be transported in its original or equivalent packaging.

1.2 Intended use

The inclination switch ISW2SP360 is a measurement device, consisting of an electronic sensor and an integrated electronic for signal processing. The device is intended to be used for the measurement of inclination in agricultural and forestry machines, commercial vehicles, cranes and lifting machines or in industrial automation, solar thermal energy and photovoltaics.

GEMAC assumes no liability for direct or indirect losses or damages resulting from the use of the product. This applies in particular for improper use which is not corresponding to the intended purpose and which is not described within this documentation.

1.3 Incorrect use

The inclination switch ISW2SP360 and the programming tool ISWPA1 do not constitute safety components according to the EC Machinery Directive (2006/42/EC). They must not be used in explosive environments. Any other use that is not described in 1.2 Intended use are prohibited. The use of accessories not explicitly approved by GEMAC is at the user's own risk.

1.4 Requirements to the qualification of personnel

The personnel who work on and with the inclination switch ISW2SP360 and the programming tool ISWPA1 must be suitably authorized, trained, and sufficiently qualified. Skilled personnel refers to the following:

- A member of staff who has received specialist training, which is backed up by additional knowledge and experience concerning the use of the inclination switch and the respective application.
- A member of staff who knows the relevant technical terms and regulations.
- A member of staff who can appraise the work assigned to them, recognize potential hazards, and take suitable safety precautions.

2 Technical Data ISW2SP360

2.1 Characteristics

- 2- dimensional inclination switch with programmable switching thresholds between $\pm 180^\circ$ or $0..360^\circ$
- 2 switching outputs, potential-free, 30 V, 500 mA, normally closed (NC) or normally open (NO)
- Supply voltage: 8 V ... 28 V
- Small, robust, simply mountable ABS-housing
- Suitable for automotive use:
 - EMC-safe according to ECE R10
- Suitable for industrial use:
 - Temperature range: -40°C ... $+75^\circ\text{C}$
 - Degree of protection: IP65/67

The inclination switch ISW2SP360 is used for one- or two-dimensional monitoring of inclination angles in ranges between $\pm 180^\circ$ or $0 \dots 360^\circ$. By using the optional available programming adapter the configuration of the switching thresholds can be realized directly. Additional functions like operating principle, vibration filter, hysteresis and dead time can be set individually by the user using the PC software. Furthermore, the switching thresholds are configurable arbitrarily on one but also on different axes.

2.2 Applications

- Agricultural and forestry machinery
- Construction machinery
- Crane and hoisting technology
- Industrial applications
- Solar thermal and photo-voltaic systems

2.3 Device description

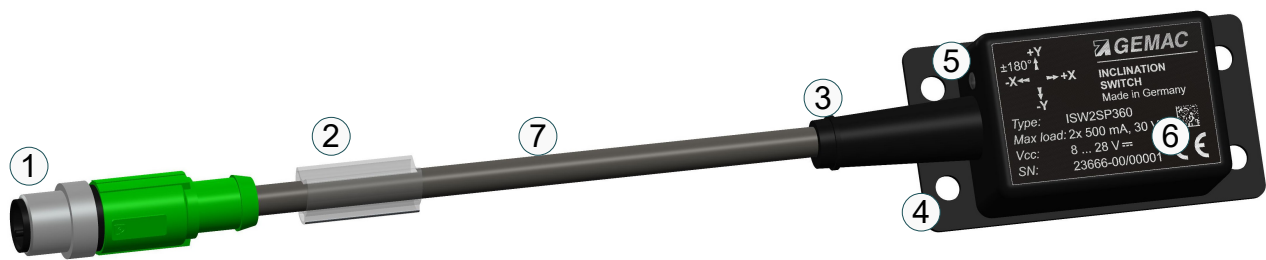

Figure 1: Device description ISW2SP360

Number in figure 1	Description
1	M12-Connector
2	Label field
3	Bend protection
4	Mounting holes
5	LED
6	Serial number
7	Flexible cable connection

Table 1: Device description ISW2SP360

2.4 Overview

General parameters: Ta = 25 °C		
Measurement axes	up to 2 axes	
Measurement range X-Axis	±180°	
Measurement range Y-Axis	±90°	
Resolution	0.01°	
Accuracy	±0.3°	
Temperature coefficient (zero-point)	±0.01 °/K	
Adjustable Cut-off frequency	0.25 Hz; 0.5 Hz; 1 Hz; 2 Hz (different values on request)	
Internal sampling rate	20 Hz	
Dead time	multiples of the internal sampling interval (50 ms), max. 30 s	
Operating temperature range	-40 °C ... +75 °C	
Characteristics		
Interface	potential free, normally closed (NC) or normally open (NO) configurable	
Electrical parameters		
Supply voltage	8 V DC ... 28 V DC	
Current consumption	3 mA ... 15 mA	
Electrical parameters switching outputs	typical	maximum
Output voltage	-	30 V
Output current	-	500 mA
ON-Resistance	0.55 Ω	2.00 Ω
Voltage drop	460 mV	530 mV
Mechanical parameters		
Connection	0.2 m PUR-cable 8x 0.25 mm ² with 8-pole M12-connector (male, A-coding)	
Degree of protection	IP65/67 ¹	
Shock survival	max. 5 000 g	
Dimensions	68 mm x 36.5 mm x 21 mm	
Mass	Approx. 55 g	
Reliability according EN ISO 13849-1 ²		
MTTF	385 years	
MTTFd	730 years	

Table 2: Overview technical parameters ISW2SP360

1 In mated condition

2 This product is a standard product and no safety part in accordance with the machinery directive. The calculation is based on an average environment temperature of 40 °C and a usage of 8760 h/a.

Electromagnetic Compatibility (EMC)

Transient Emissions

Radiated disturbance / Radio field strength	Limit curves broadband and narrowband according to UN ECE R10 (automotive), superior to DIN EN ISO 14982 (agricultural and forestry machinery) respectively DIN EN 13309 (construction machinery) 30 ... 1000 MHz (vertical and horizontal)
---	---

Immunity to Radio Frequency Fields (RF fields)

Strip line according to ISO 11452-5	Limits superior to UN ECE R10 (automotive), DIN EN ISO 14982 (agricultural and forestry machinery) respectively DIN EN 13309 (construction machinery) 20 ... 400 MHz 100 V/m Functional status A
Absorber chamber according to ISO 11452-2	Limits superior to UN ECE R10 (automotive), DIN EN ISO 14982 (agricultural and forestry machinery) respectively DIN EN 13309 (construction machinery) 200 ... 1000 MHz, 30 V/m (vertical and horizontal) 800 ... 2000 MHz, 30 V/m (vertical and horizontal) Functional status A

Immunity to Conducted Disturbances (on-board power supply 24 VDC)

Test pulse according to ISO 7637-2	Limits according to UN ECE R10 (automotive)		
	Test pulse number	Immunity test level	Functional status for system
	1 -450 V	III	C
	2a +37 V	III	B
	2b +20 V	III	C
	3a -150 V	III	A
	3b +150 V	III	A
	4 -12 V	III	A
	Further tests		
	5a +70 V	Ri = 10 Ω	B
5b +36 V	Ri = 0,5 Ω	B	

Immunity to Electromagnetic Discharge (ESD)

ESD according to ISO 10605	Limits according to DIN EN ISO 14982 (agricultural and forestry machinery) respectively DIN EN 13309 (construction machinery) discharge combination 330 pF / 2 kΩ Contact discharge 6 kV bipolar (metallic parts) Air discharge 8 kV bipolar Functional status A
----------------------------	--

Table 3: Electromagnetic Compatibility (EMC) ISW2SP360

2.5 Orientation of measurement axes

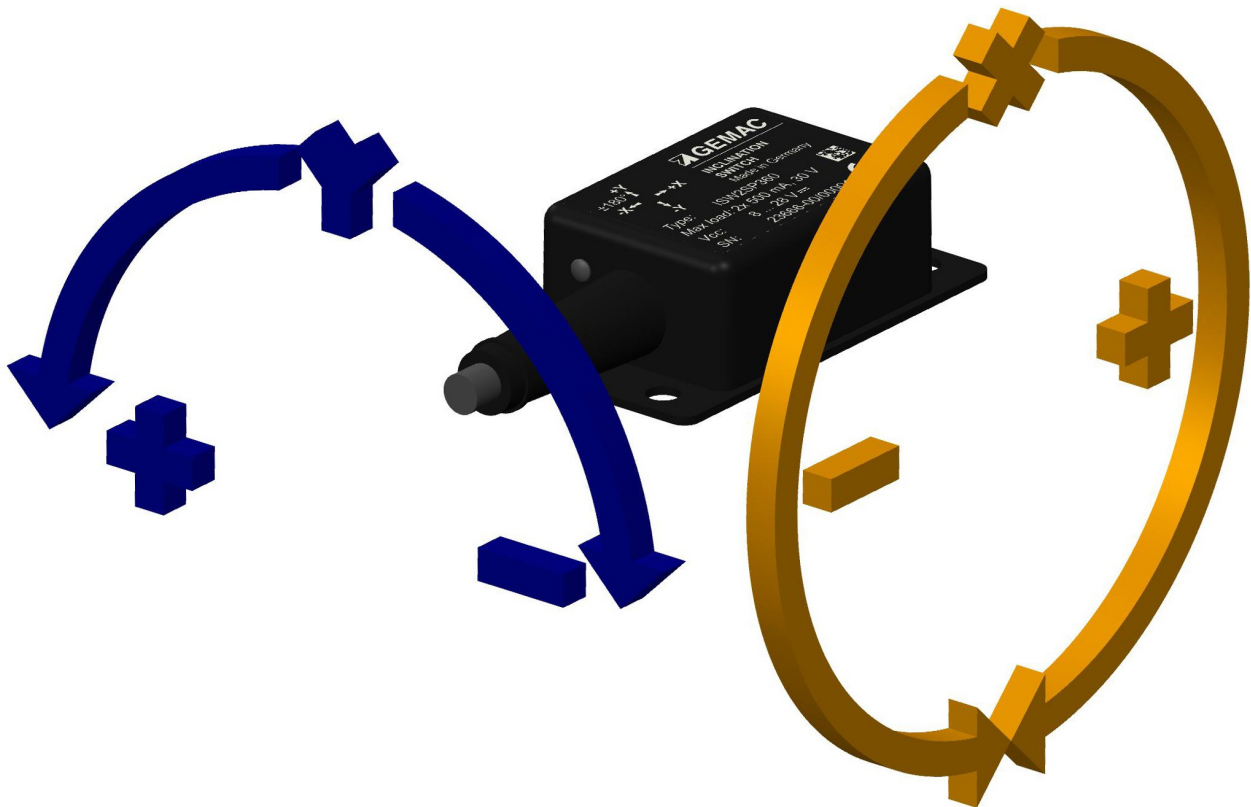

Figure 2: Orientation of measurement axes ISW2SP360

2.6 M12 Plug connector pin assignment

Pin	Wire color	Signal	Pin assignment	Note	Figure (view from the outside)
1	white	A+	Positive switching output A		
2	brown	A-	Negative switching output A		
3	green	B+	Positive switching output B		
4	yellow	B-	Negative switching output B		
5	grey	T1	Signal programmer	connect to Ground	
6	pink	T2	Signal programmer	connect to Ground	
7	blue	GND	Ground		
8	red	V+	Supply voltage		

Table 4: M12 Plug connector pin assignment ISW2SP360

2.7 Block diagram

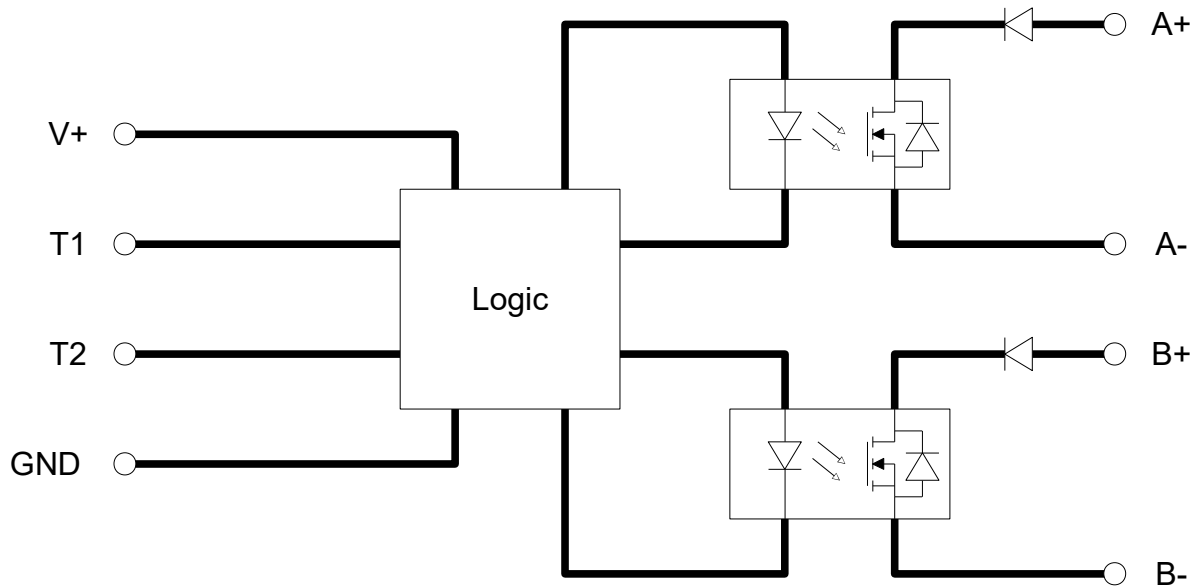

Figure 3: Block diagram ISW2SP360

2.8 Mounting

The holes for screw-mounting the inclination switch are located in its base plate. (see Figure 4).

2.9 Dimensioned drawing

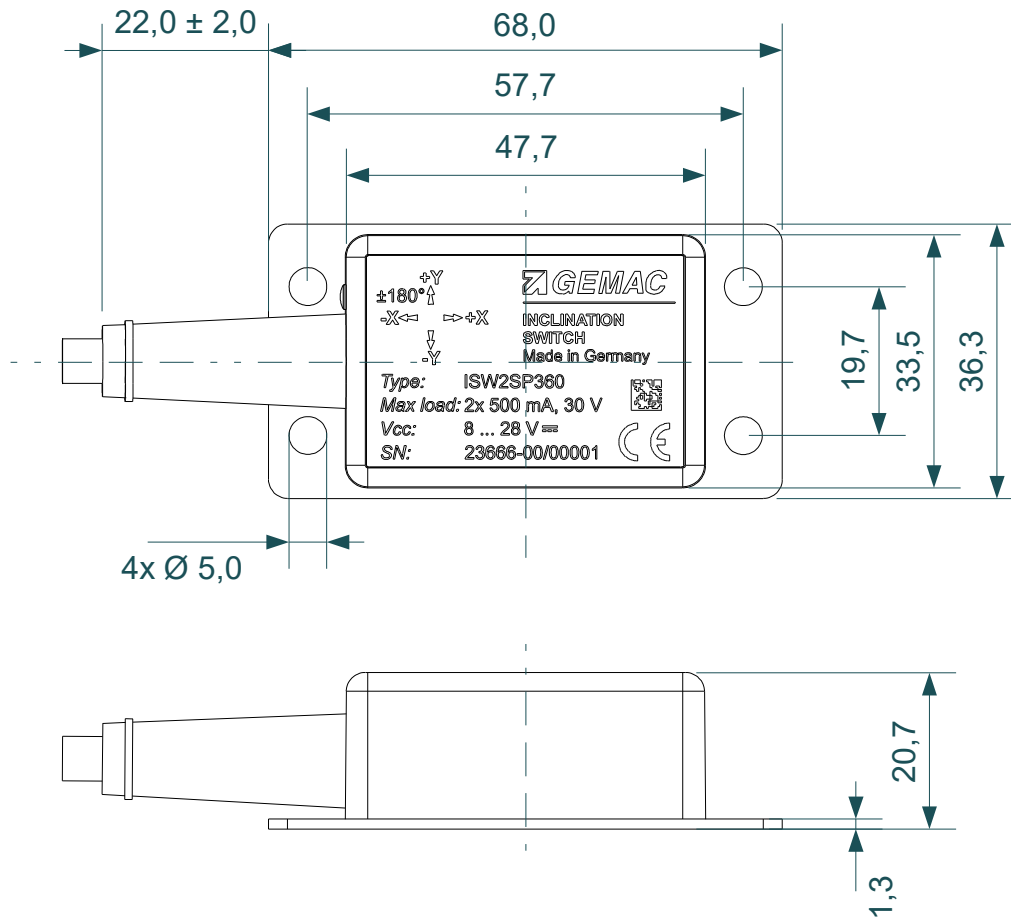

Figure 4: Dimensioned drawing ISW2SP360 (dimensions in mm)

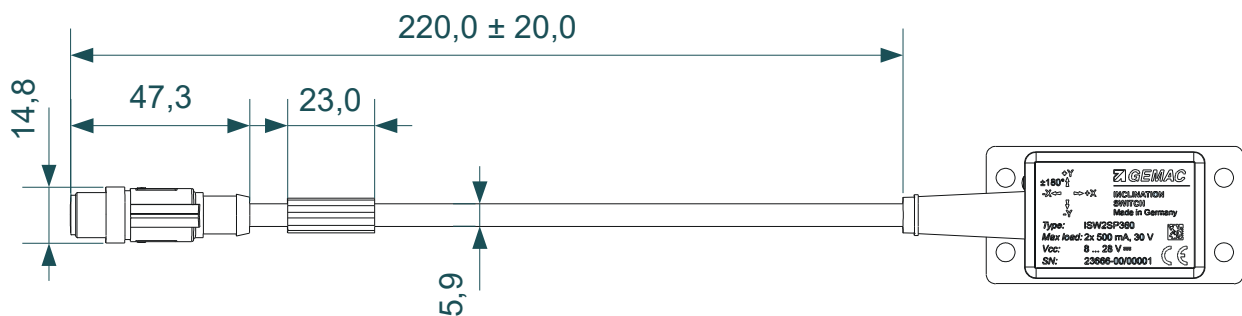

Figure 5: Dimensioned drawing connection cable ISW2SP360 (dimensions in mm)

2.10 Factory settings

Parameter	Value
Cut-off frequency:	1000 mHz
Zero point offset X:	0°
Zero point offset Y:	0°
Switch A – output:	X-axis
Switch A – contact type:	break contact
Switch A – lower switching threshold:	-10.00°
Switch A – upper switching threshold:	10.00°
Switch A – dead time:	0 ms
Switch A – hysteresis:	0.5°
Switch B – output:	Y-axis
Switch B – contact type:	Break Contact
Switch B – lower switching threshold:	-10.00°
Switch B – upper switching threshold:	10.00°
Switch B – dead time:	0 ms
Switch B – hysteresis:	0.5°

Table 5: Factory settings ISW2SP360

2.11 Function of the LED



LED state	Description
Green, flashing 	Inclination switch operational
Red, permanent 	Inclination switch is receiving a message from the programming tool

Table 6: LED function ISW2SP360

2.12 Special features of the inclination switch

To ensure that the switching outputs are closed, the inclination switch needs to be connected to a power supply. In case of a breakdown of the supply voltage, the outputs will open up, independent of the position of the inclination switch itself.

The definition of the axes of the inclination switch is as follows: X-axis measurement range is defined over a whole circle from -180° to +180° (or 0° to 360° respectively), while the Y-axis is defined over a semicircle from -90° to +90°. Resulting from this definition, each position in space has a one-to-one correspondence to a single pair of inclination values. If the sensor's Y-axis is inclined above +90° or below -90°, the absolute angle value is starting to decrease until it reaches zero again in the overhead position. (see fig. 6). The angle values of the Y-axis are mirrored horizontally. For better understanding of the behavior of the inclination switch, the Sensor-3D-View of the ISwitchControl-Software can be used (refer to section 7.2.6 View „Sensor 3D-View“).



Angle Y = -80°

Angle Y = -90°

Angle Y = -80°

Figure 6: Angle overrun of the Y-axis

Due to the horizontal mirroring of the angle values of the Y-axis the switching thresholds are mirrored respectively (see fig. 7).

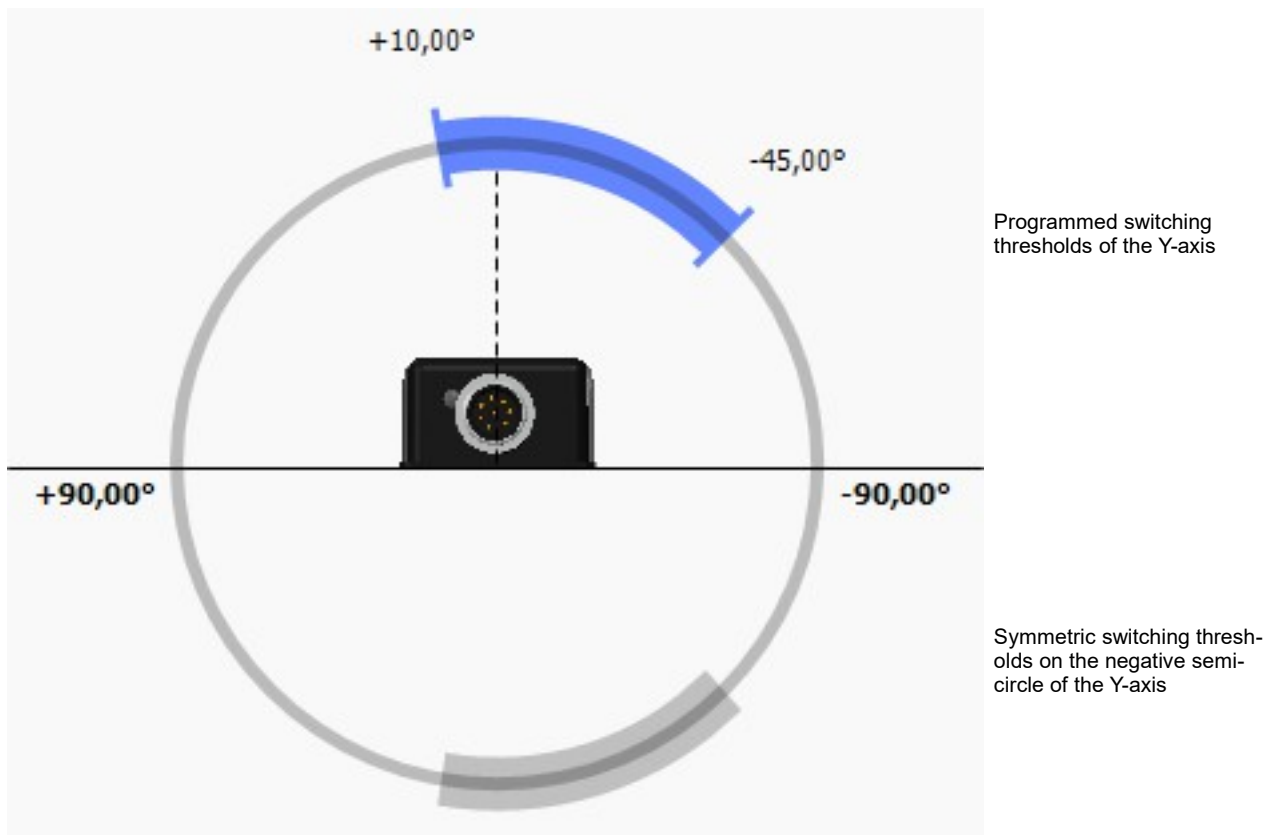

Figure 7: Switching thresholds of the Y-axis

The inclination switch is calculating its inclination by processing the acceleration measurement of the earth's gravitational field. Additional accelerations, e.g. from accelerating or decelerating a vehicle or driving through a curve, are disturbing the inclination switch's proper function and should therefore be avoided while measuring.

Due to the measurement principle the inclination switch is not able to detect angle value changes on one of the axes if they are moved perpendicular to the earth's gravitational field vector. (see fig. 8).

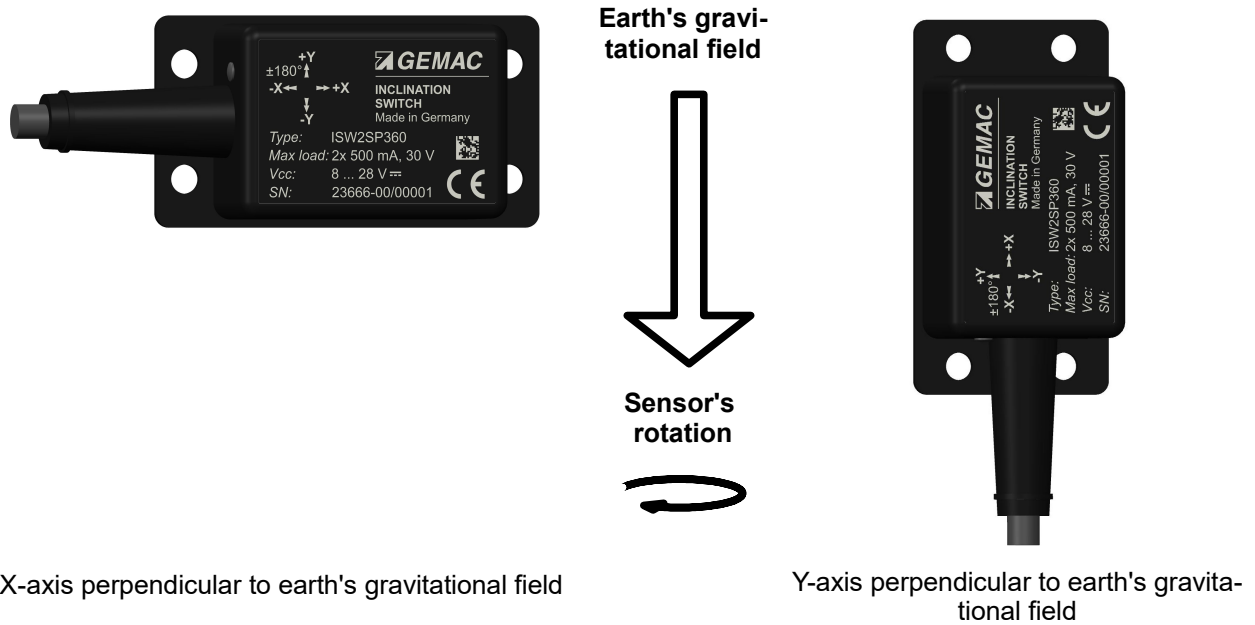

Figure 8: Examples of angle value changes which can not be detected: X-axis (left) and Y-axis (right)

3 Technical Data Programming Device ISWPA1

3.1 Characteristics

Using the programming device ISWPA1 you can easily configure any connected inclination switch of type ISW2SP360. The power supply can be realized via the M12-connector or by an USB connection. Either way, the inclination switch is powered through the programming device.

The pinning of the M12 male and female connectors is chosen in a way that allows the programming device to be connected in series between the inclination switch and a control unit.

3.2 Device description



Figure 9: Device description ISWPA1

Number in figure 9	Description	Note
1	M12-Connector (male)	Connection to control unit (e.g. SPS)
2	M12-Connector (female)	Connection to inclination switch ISW2SP360
3	USB-Connector	Connection to PC
4	Button „Switch A“	
5	Button „Switch B“	
6	LED „Switch A“	
7	LED „Switch B“	
8	LED „USB“	
9	Serial number	

Table 7: Device description ISWPA1

3.3 Overview

General parameters:	
Operating temperature range	0 °C ... +70 °C
Maximum length of cable-connection to inclination switch	50 m
Electrical Parameters	
Supply voltage V+	8 V DC ... 36 V DC
Current consumption V+	25 mA ... 27 mA + I _{sensor}
Supply voltage USB	4.4 V ... 5.5 V
Output voltage SV+	10 V ... V+ - 0,7 V
Mechanical Parameters	
Input	M12-Connector male 8-pole A-coding
Output	M12-Connector female 8-pole A-coding
Degree of protection	IP54 ³
Dimensions	1445 mm x 744 mm x 528 mm
Mass	Approx. 300 g

Table 8: Overview technical parameters ISWPA1

3.4 M12-Connector male pin assignment

Pin	Wire color	Signal	Pin assignment	Note	Figure (view from the outside)
1	white	A+ IN	Positive switching output A	Internally connected to A+ OUT	
2	brown	A- IN	Negative switching output A	Internally connected to A- OUT	
3	green	B+ IN	Positive switching output B	Internally connected to B+ OUT	
4	yellow	B- IN	Negative switching output B	Internally connected to B- OUT	
5	gray	R1	reserved	connect to Ground	
6	pink	R2	reserved	connect to Ground	
7	blue	GND	Ground		
8	red	V+	Supply voltage		

Table 9: M12-Connector male pin assignment ISWPA1

³ In mated condition

3.5 M12-Connector female pin assignment

Pin	Wire color	Signal	Function	Note	Figure (view from the outside)
1	white	A+ OUT	Positive switching output A	Internally connected to A+ IN	
2	brown	A- OUT	Negative switching output A	Internally connected to A- IN	
3	green	B+ OUT	Positive switching output B	Internally connected to B+ IN	
4	yellow	B- OUT	Negative switching output B	Internally connected to B- IN	
5	gray	T1	Signal inclination switch		
6	pink	T2	Signal inclination switch		
7	blue	GND	Ground		
8	red	SV+	Supply voltage inclination switch		

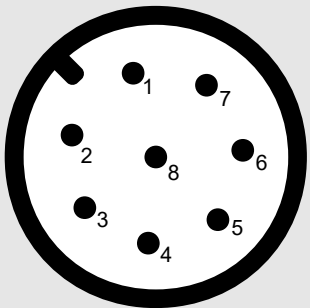
Table 10: M12-Connector male pin assignment ISWPA1

3.6 Block diagram

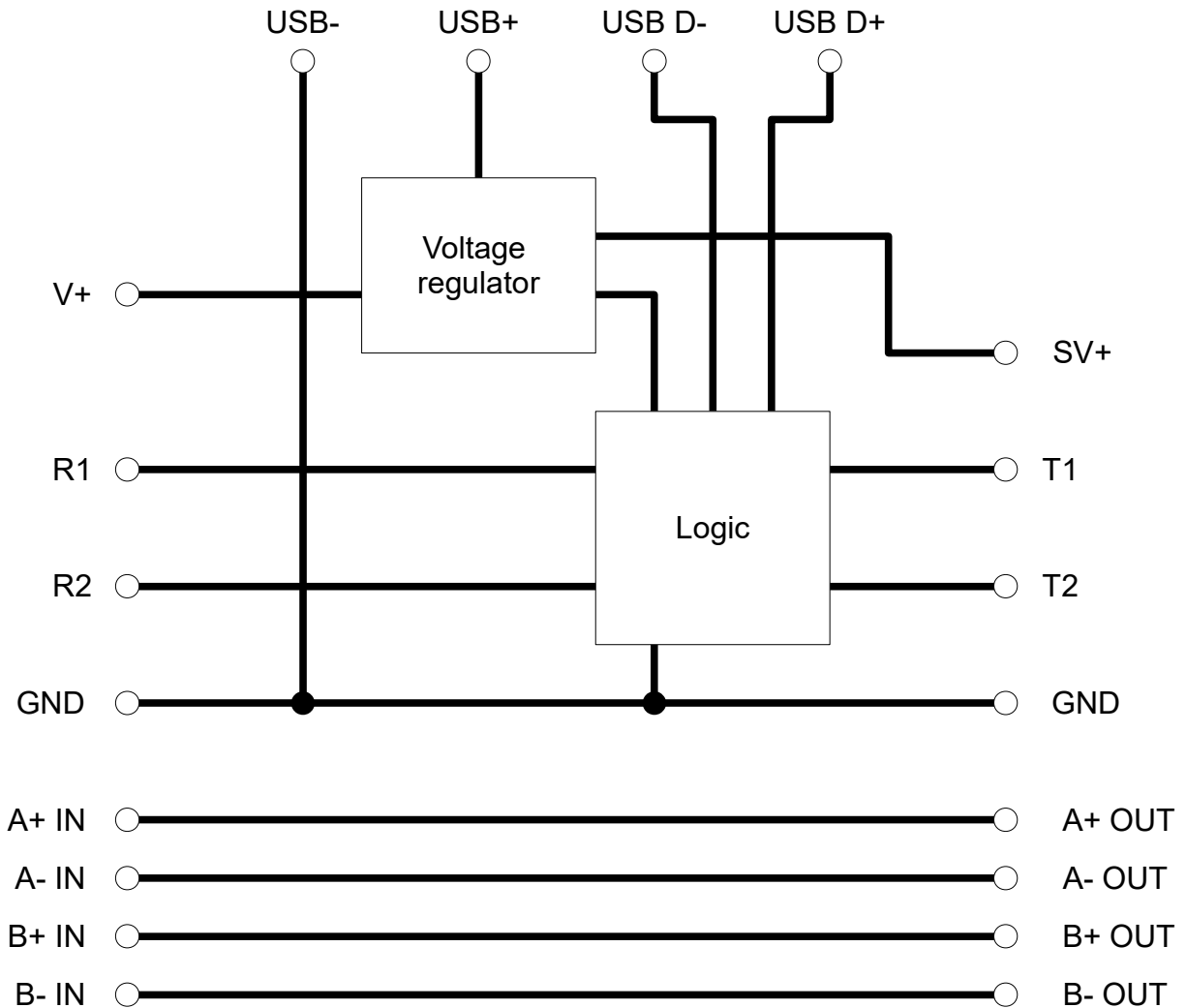

Figure 10: Block diagram ISWPA1

3.7 Function of the LEDs







Name of LED	LED status	Description
„Switch A“ + „Switch B“	Green 	Inclination switch ISW2SP360 connected
	Red 	Programming device is sending Zero-Point information to the connected ISW2SP360
„USB“	Green 	Programming device operational
	Orange 	Programming device operational and connected to a PC via USB
„Switch A“	Red 	Programming device is sending switching point to switch A of the connected ISW2SP360
„Switch B“	Red 	Programming device is sending switching point to switch B of the connected ISW2SP360

Table 11: LED function ISWPA1

4 Definition of Terms

4.1 Zero-point

The inclination switch is calibrated at the factory to output a value of 0° in horizontal position (zero-point) at both measurement axis (X- and Y-Axis).

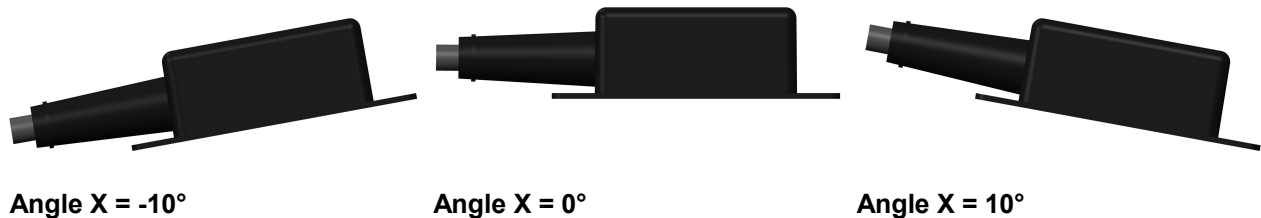

Figure 11: Angle X, factory settings

It is possible to adjust this zero-point to the relevant application. Information of the factory-calibrated zero-point is not deleted thereby and can be restored. Fig. 12 shows the behavior of angle X when a zero-point of -10° for X-axis and 0° for Y-axis is adjusted.

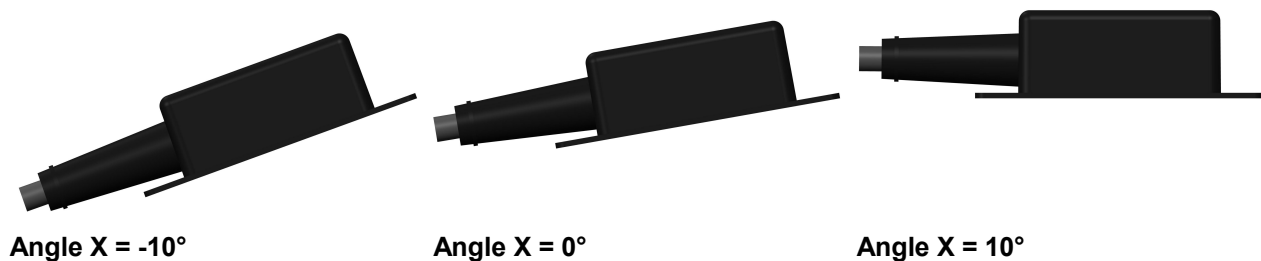

Figure 12: Angle X, Zero-point set to $X = -10^\circ$

4.2 Hysteresis

Hysteresis characterizes the distance between switching threshold and switching back threshold.

The inclination switch will toggle between both switching status permanently, when it is positioned at the switching threshold accurately. This behavior can be prevented by using a suitable hysteresis.

The factory settings of the inclination switch can be seen in table 5. Switching thresholds are set to $\pm 10^\circ$, hysteresis is set to 0.5° . The switch will break contact, when the corresponding axis of the inclination switch is inclined in positive direction and reaches 10° (switching threshold). The switch will make contact, when the corresponding axis of the inclination switch is inclined in negative direction afterwards and reaches 10° (switching threshold) $- 0.5^\circ$ (hysteresis) = 9.5° (switching back threshold).

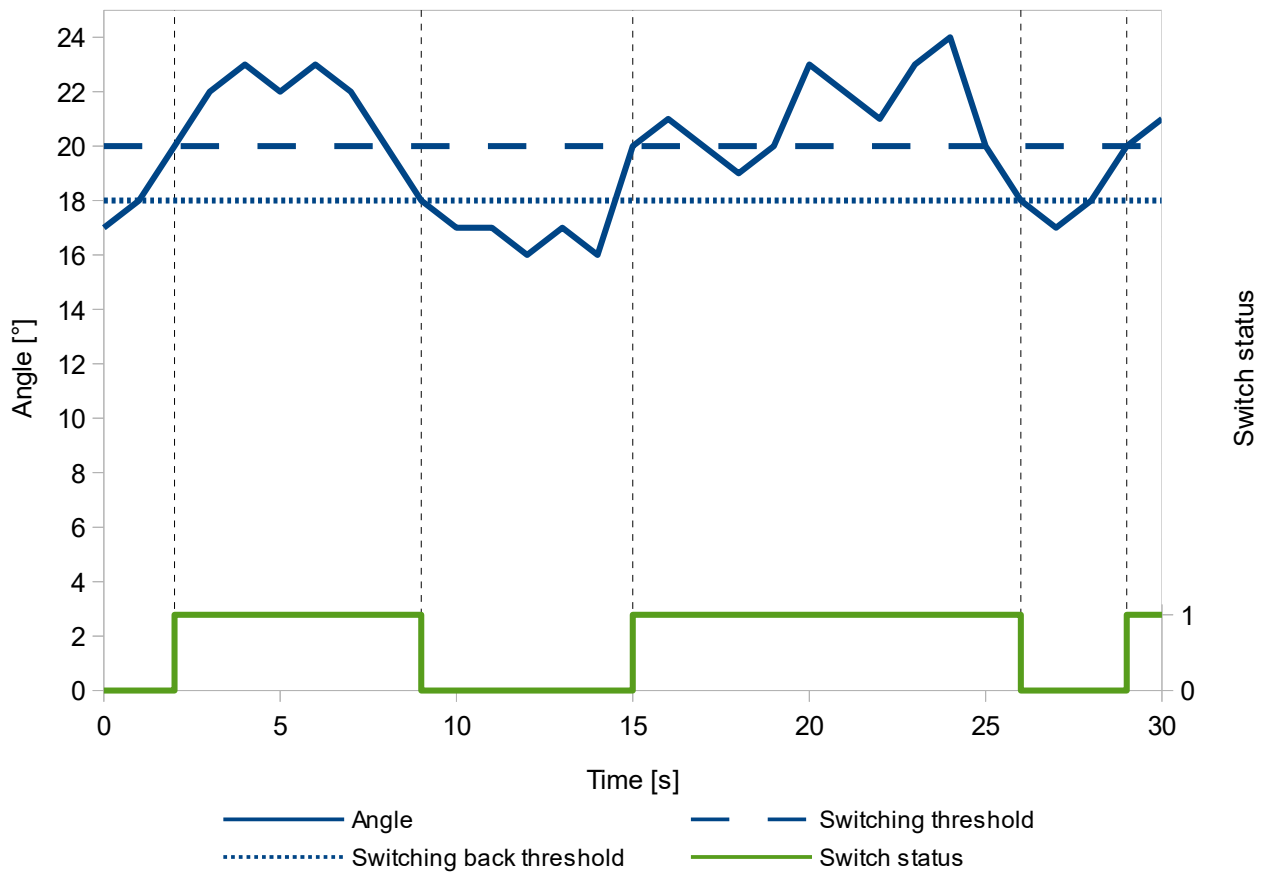

Figure 13: Example hysteresis of 2°

4.3 Dead time

Dead time characterizes how long the switch will stay in the current state after the switching threshold is exceeded.

Once the switching threshold or the switching back threshold of an axis is exceeded, the dead time counter starts to count. The corresponding switching output will not be changed before dead time is elapsed. The switching output will not be changed, if the switching threshold is underrun while the dead time counter is counting.

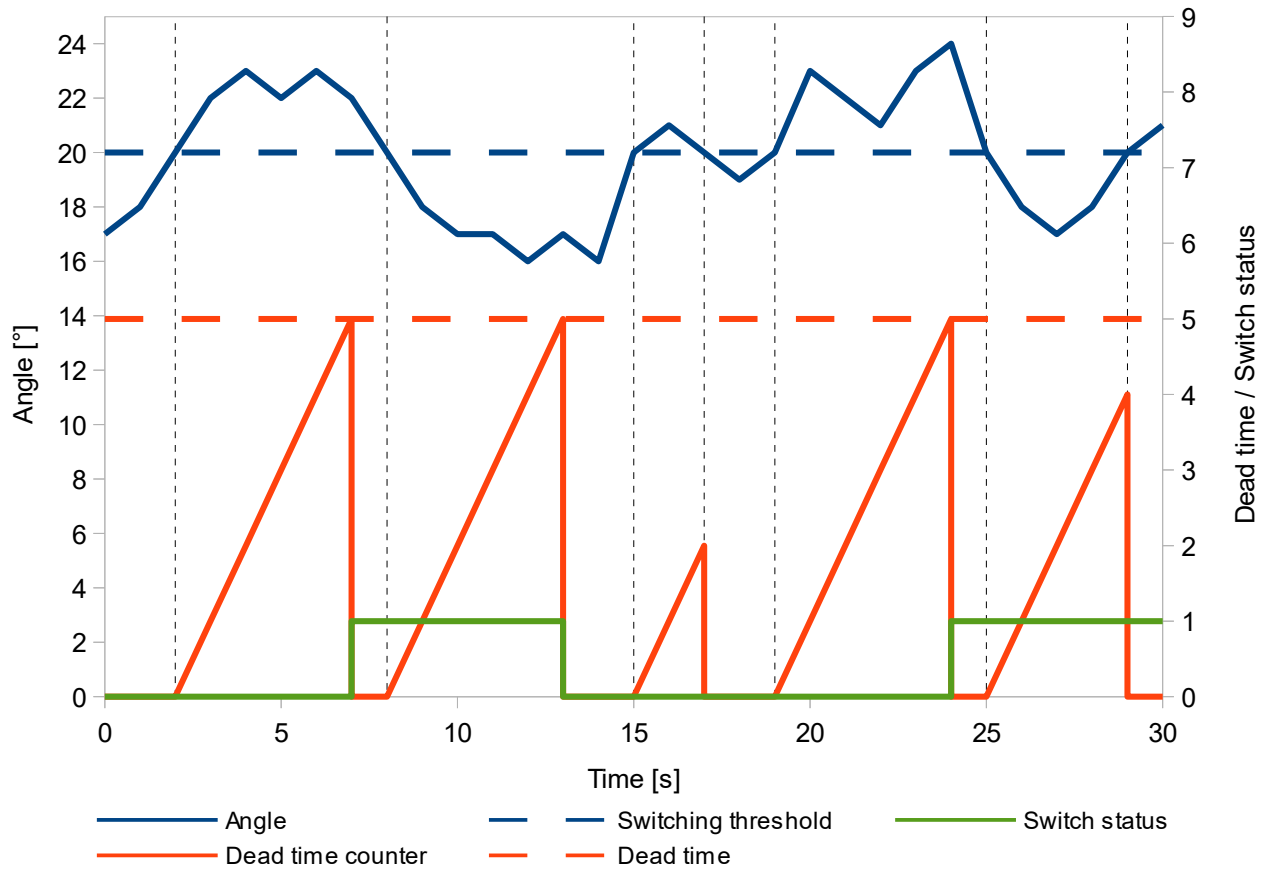

Figure 14: Example hysteresis of 5 seconds

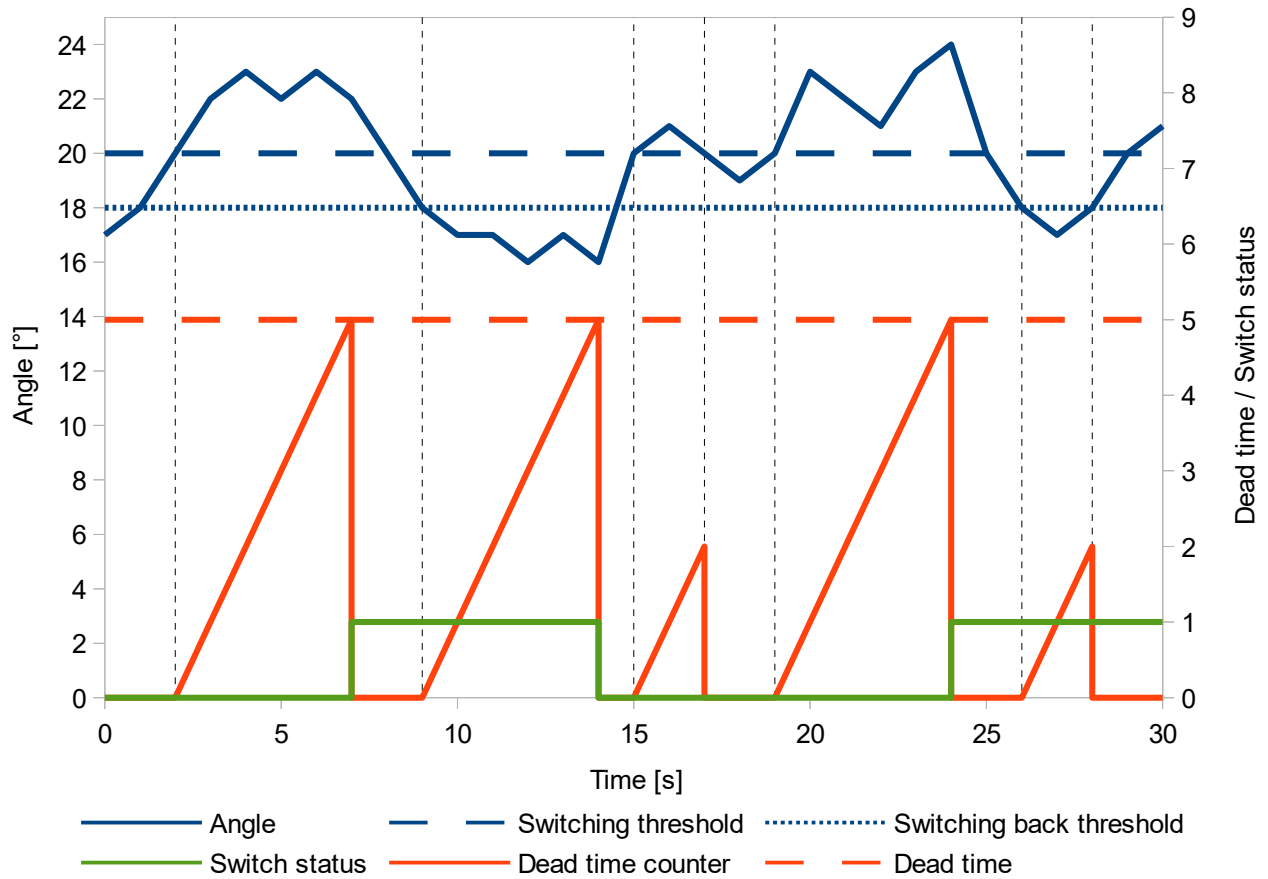

Figure 15: Example hysteresis of 2° and dead time 5 seconds

5 Adjustment of Switching Thresholds with the Programming Device ISWPA1

You can connect an inclination switch ISW2SP360 to the programming device ISWPA1 via female M12-Connector and adjust the inclination switch according to table 12.

The programming device has to be supplied via V+-Pin at the male M12-Connector and must not be connected to a computer via USB. The LED "USB" will illuminated orange, when both conditions are met.

Keystroke	Action	Description
„Switch A“	Set switching threshold of switch A	The current angle value of the axis related to switch A is set as switching threshold. The angles absolute value is set as upper switching threshold, the additive inverse is set as lower switching threshold.
„Switch B“	Set switching threshold of switch B	The current angle value of the axis related to switch B is set as switching threshold. The angles absolute value is set as upper switching threshold, the additive inverse is set as lower switching threshold.
„Switch A“ + „Switch B“	Set zero-point	The current position of the inclination switch is set as zero-point.

Table 12: Adjustments of ISWPA1

5.1 Example of adjusting switching thresholds

In this example, it is assumed that the inclination switch is set to factory settings according to table 5. In this case switch A is related to the X-axis and switch B to the Y-axis. The inclination switch is inclined in a way that it measures the angle values shown in table 13.

The behavior of the inclination switch ISW2SP360 at different keystrokes can be seen in table 14.

Axis	Angle value
X-Axis:	20°
Y-Axis:	-15°

Table 13: Example angle values

Keystroke	System behavior	
	Parameter	New value
„Switch A“	Switch A – Lower Switching Threshold:	-20°
	Switch A – Upper Switching Threshold:	20°
„Switch B“	Switch B – Lower Switching Threshold:	-15°
	Switch B – Upper Switching Threshold:	15°
„Switch A“ + „Switch B“	Zero-Point Offset X:	20°
	Zero-Point Offset Y:	-15°

Table 14: Example of adjusting switching thresholds

6 Start-up ISwitchControl

6.1 System requirements

For proper performance of the PC software your PC or notebook must have the following minimum requirements and use one of the operating systems listed below.

Hardware:

- Processor: 2.0 GHz or more
- minimum 1 GB main memory
- Graphic board with 24 Bit -color depth (32 Bit recommended)
- Resolution: 1024x768 Pixel or more
- free USB interface

Supported operating systems⁴:

- Microsoft Windows[®] 7 (32 Bit and 64 Bit)
- Microsoft Windows[®] 8 (32 Bit and 64 Bit)
- Microsoft Windows[®] 8.1 (32 Bit and 64 Bit)
- Microsoft Windows[®] 10 (32 Bit and 64 Bit)

6.2 Installation of software and driver

The PC software is available in German and English language. Installation of ISwitchControl will also install an USB driver on your computer, which is necessary for the programming device.

Windows[®] Device Manager will show the the programming device as „STMicroelectronics Virtual COM Port (COMx)“ after proper installation.

Note:

To install the USB driver, you will require administrator rights.

6.3 Connecting the inclination switch

Connect the inclination switch with your computer as shown in fig. 16.

⁴ Microsoft and Windows[®] are registered trademarks of Microsoft Corporation in the USA and other countries.

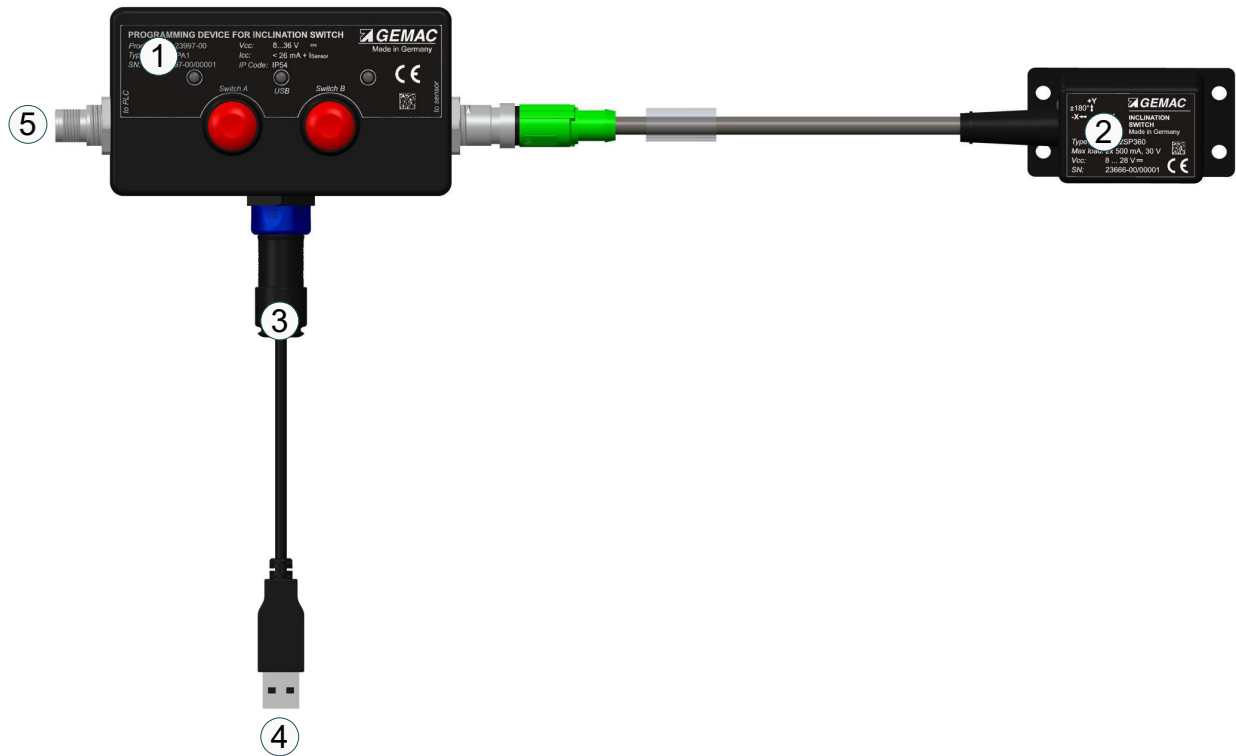

Figure 16: Connecting programming device and inclinations switch with a computer

Number in fig 16	Description
1	Programming device ISWPA1
2	Inclination switch ISW2SP360
3	Mini 'B' USB-Cable PX0441 ⁵
4	Connection to PC
5	Optional connection to logic controller

⁵ Protection class IP54 can not be guaranteed if you use another Mini 'B' USB-cable.

7 ISwitchControl

7.1 General notes on operation

7.1.1 Help

Many elements of the user interface display detailed explanations when the mouse pointer is moved over a control element (tooltip or status text).

The manual is also supplied in electronic form and can be called up both via the help function and with the F1 key.

7.1.2 Data saving

You can store all configurations that can be adjusted via ISwitchControl in a document with the file extension ".isw". The document can be opened either by double-clicking on the file in the Windows® Explorer or by dragging the file to the program (drag & drop).

There is an export function which can store the configurations to a PDF-file.

Your desired configuration can be programmed by factory in series production against a fee. This reduces work and handling requirements in your particular application.

7.2 Program structure

The graphical user interface of the ISwitchControl program includes a toolbar and the views "Sensor Info", "Sensor Configuration", "Sensor 3D-View" and "Sensor Oscilloscope". All views can be freely arranged in the program window or undocked from it.

7.2.1 Toolbar

You need to choose the right serial interface of the connected programming device ISWPA1 (see section 6.2 Installation of software and driver) in the toolbar to communicate with it. Once the programming device is detected, its firmware version will be shown in the "Sensor Info" - "Connected Interface" view.

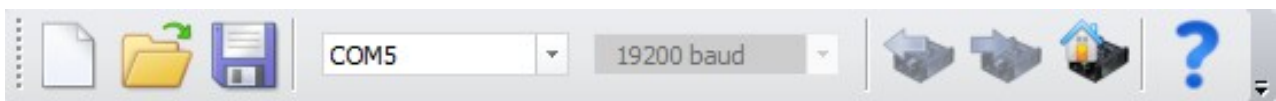
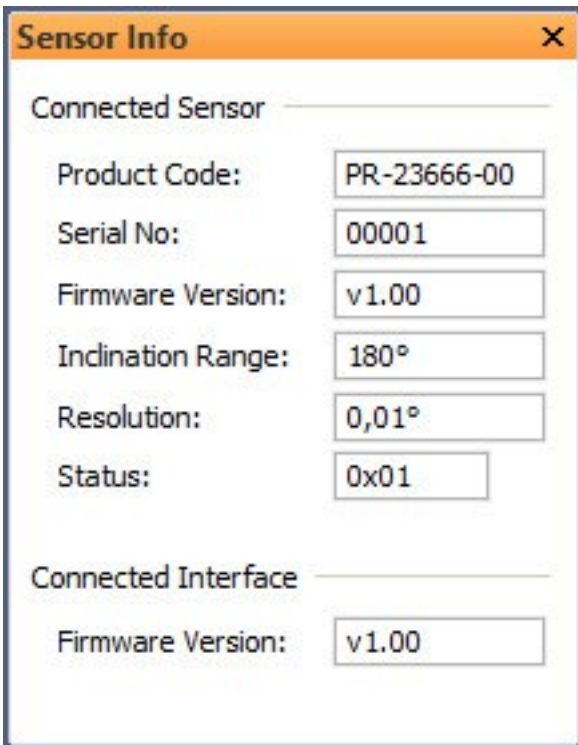

Figure 17: Toolbar

Once an inclination switch is connected to the programming device and detected by ISwitchControl, the entire sensor configuration can be read and written via toolbar. The inclination switch's factory setting can be reset via toolbar.

7.2.2 View „Sensor Info“

In this view, basic information (serial number, firmware version etc.) about the connected sensor and the firmware version of the programming device is displayed.



The screenshot shows a dialog box titled "Sensor Info" with a close button (X) in the top right corner. The dialog is divided into two sections: "Connected Sensor" and "Connected Interface".

Connected Sensor	
Product Code:	PR-23666-00
Serial No:	00001
Firmware Version:	v1.00
Inclination Range:	180°
Resolution:	0,01°
Status:	0x01

Connected Interface	
Firmware Version:	v1.00

Figure 18: View sensor info

7.2.3 View „Sensor Configuration All Parameters“

This view allows you to see the data from the document and data stored in the sensor in contrast. Differences between document and sensor data are highlighted by color.

You can transmit the data from the document into the inclination switch via the red arrow (→). You can read data from the inclination switch into the document via the green arrow (←). Alternatively you can update document and sensor data via toolbar (see section 7.2.1 Toolbar). You can set the current position of the inclination switch as zero-point via **Auto** button.

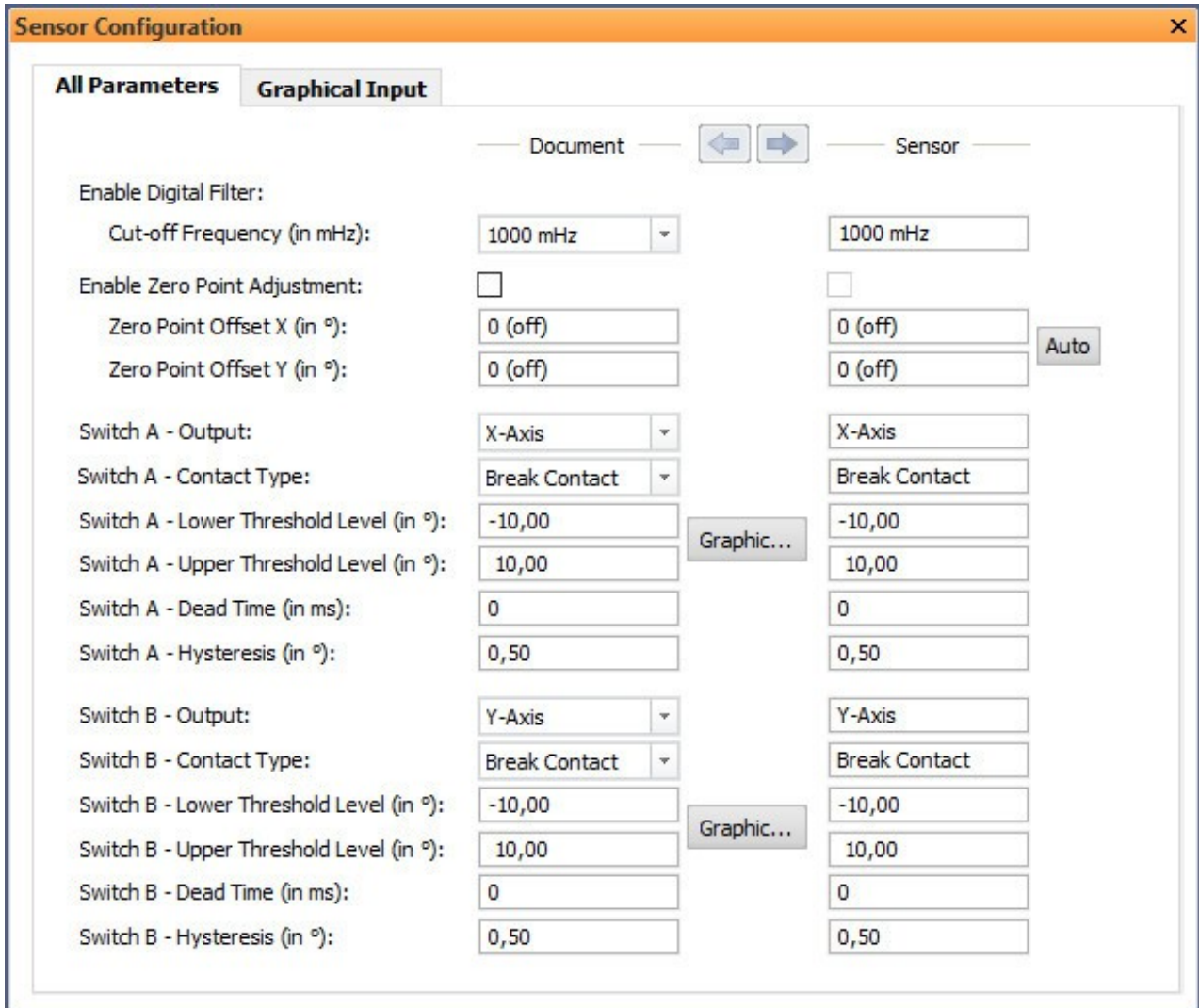

	Document	Sensor
Enable Digital Filter:		
Cut-off Frequency (in mHz):	1000 mHz	1000 mHz
Enable Zero Point Adjustment:	<input type="checkbox"/>	<input type="checkbox"/>
Zero Point Offset X (in °):	0 (off)	0 (off)
Zero Point Offset Y (in °):	0 (off)	0 (off) Auto
Switch A - Output:	X-Axis	X-Axis
Switch A - Contact Type:	Break Contact	Break Contact
Switch A - Lower Threshold Level (in °):	-10,00	-10,00
Switch A - Upper Threshold Level (in °):	10,00	10,00
Switch A - Dead Time (in ms):	0	0
Switch A - Hysteresis (in °):	0,50	0,50
Switch B - Output:	Y-Axis	Y-Axis
Switch B - Contact Type:	Break Contact	Break Contact
Switch B - Lower Threshold Level (in °):	-10,00	-10,00
Switch B - Upper Threshold Level (in °):	10,00	10,00
Switch B - Dead Time (in ms):	0	0
Switch B - Hysteresis (in °):	0,50	0,50

Figure 19: Sensor configuration all parameters

7.2.4 View „Sensor Configuration Graphical Input“

You can adjust a connected inclination switch via graphic in this view. Threshold levels can be selected and moved via mouse cursor. The particular switch status is highlighted by color.

Symmetric switching thresholds on the negative semicircle of the Y-axis (see section 2.12 Special features of the inclination switch) are shown in gray color, when the Y-axis is related to one of the switches.

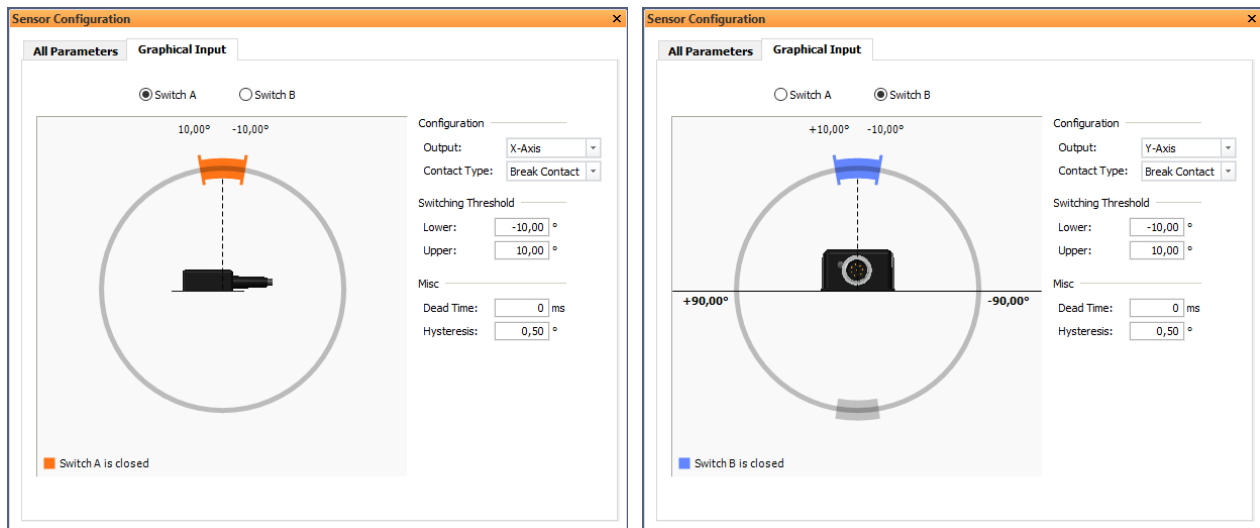

Figure 20: Sensor configuration graphical input

If you relate one sensor axis to both switching outputs, the status of the switch which is not chosen yet is displayed in addition.

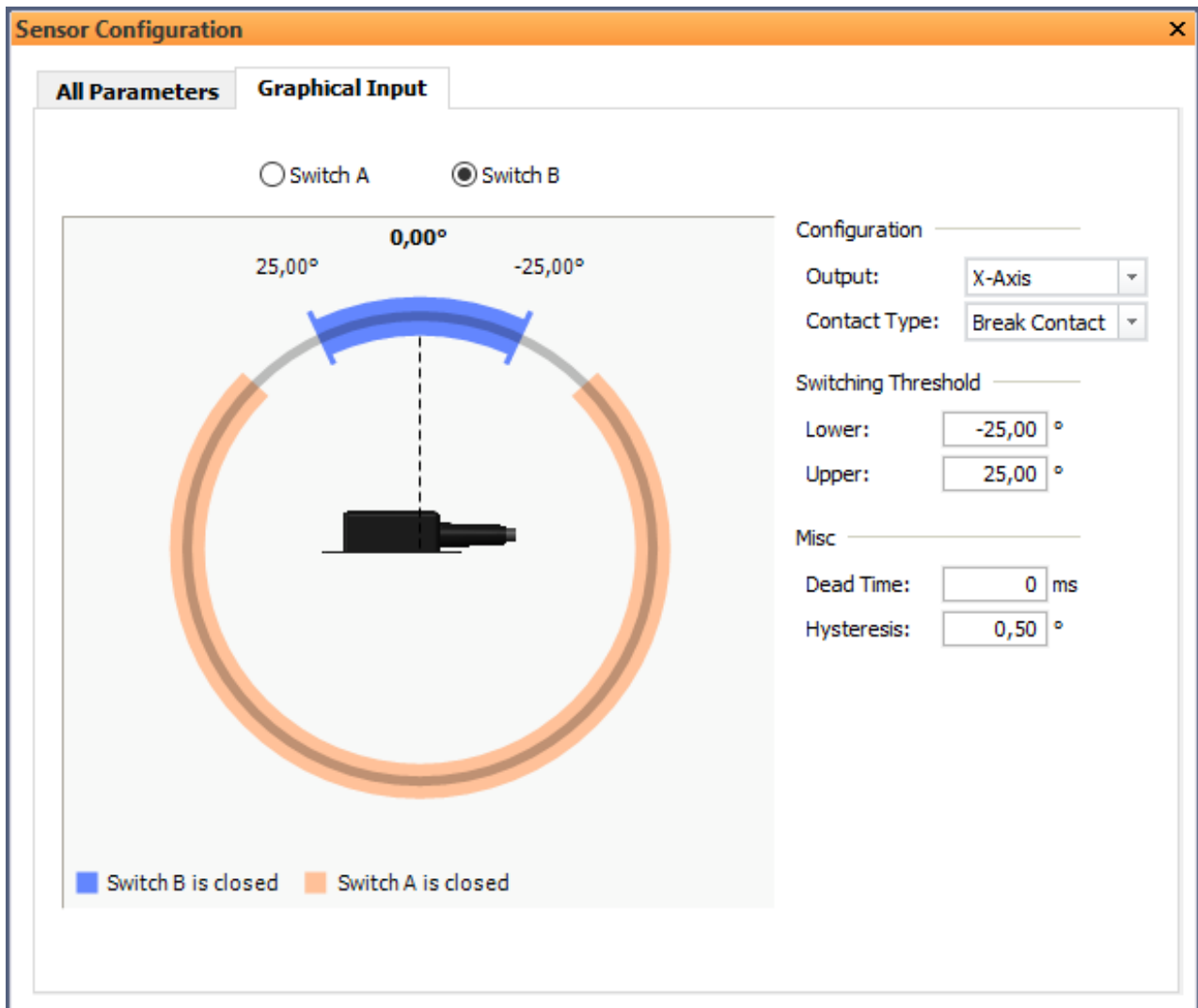
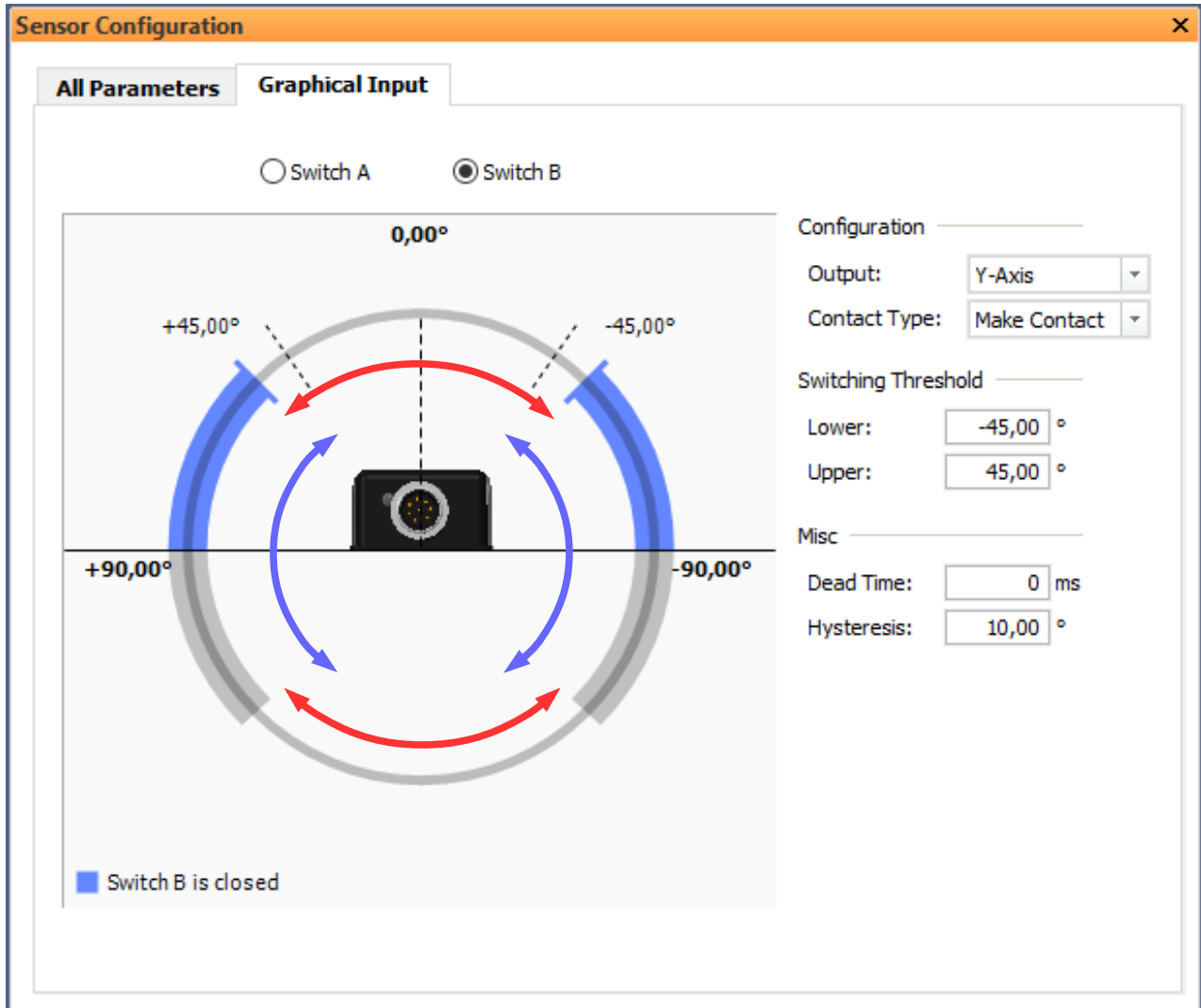

Figure 21: Sensor configuration graphical input – example for relation of X-axis to both switching outputs

7.2.5 Hysteresis representation in the “Sensor Configuration Graphical Input” view

Switching back thresholds are represented by dashed lines, when a hysteresis $>1.00^\circ$ is set.

Behavior of the switching outputs at different settings hysteresis are shown in the following figures.



Switch B is open Switch B is closed

Figure 22: Sensor Configuration Graphical Input – Example for hysteresis of 10° and switching threshold levels of $-45^\circ/+45^\circ$ on the Y-axis (Make Contact)

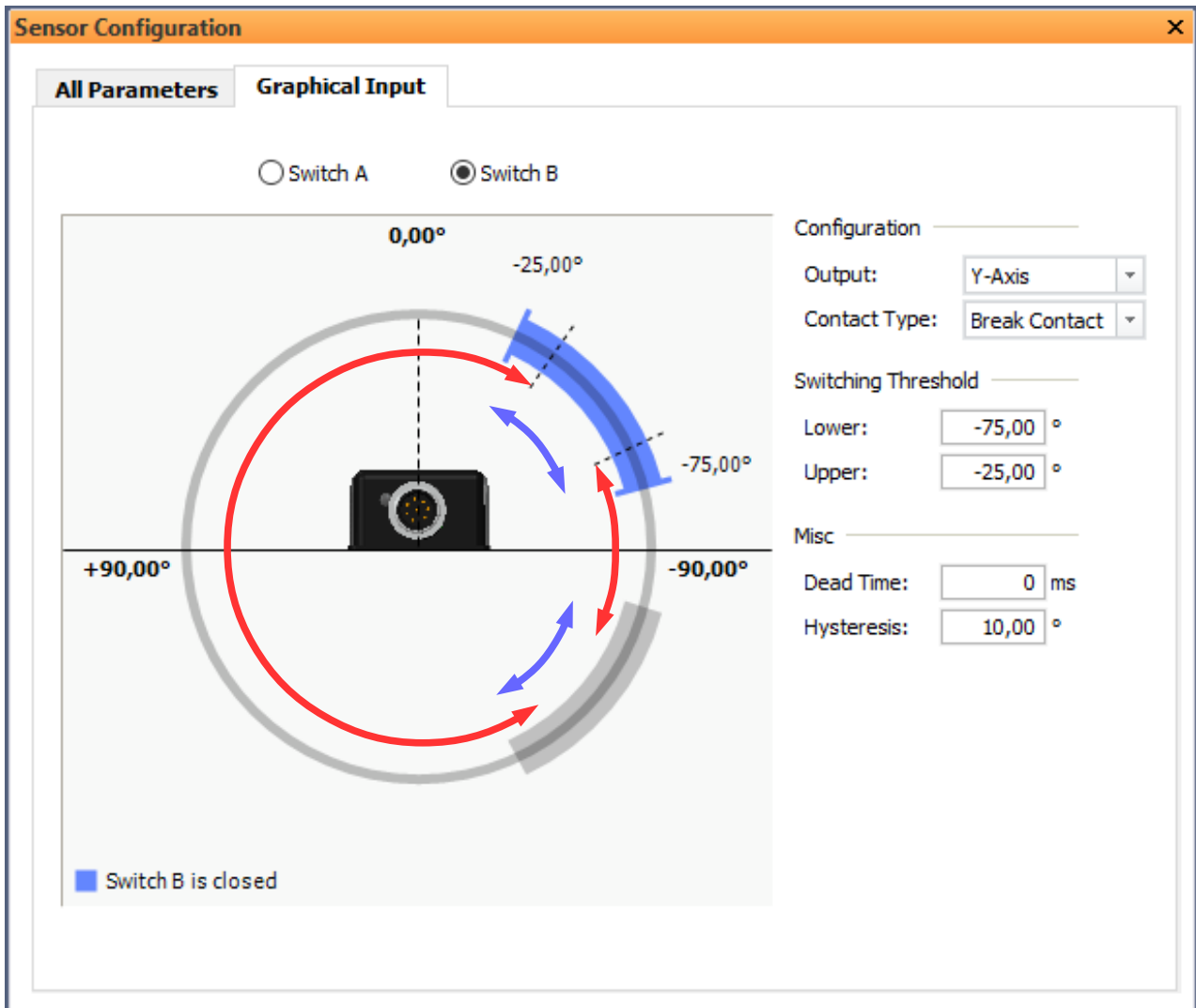

Switch B is open Switch B is closed

Figure 23: Sensor Configuration Graphical Input – Example for hysteresis of 10° and switching threshold levels of -75°/-25° on the Y-axis (Break Contact)

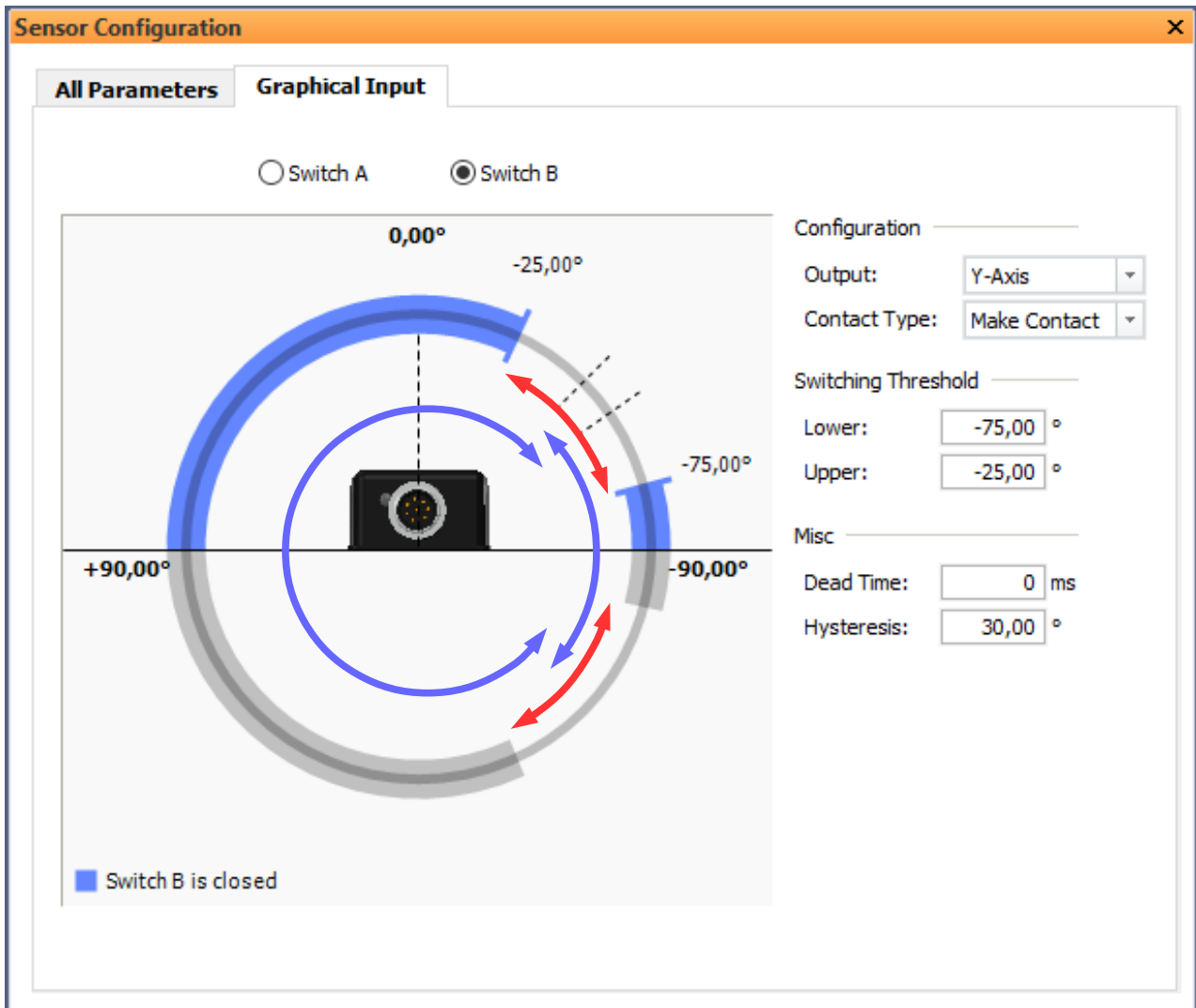

Switch B is open Switch B is closed

Figure 24: Sensor Configuration Graphical Input – Example for hysteresis of 30° and switching threshold levels of -75°/-25° on the Y-axis (Make Contact)

7.2.6 View „Sensor 3D-View“

You can see the sensors orientation in space, the current angles X and Y and the current status of the switches A and B⁶ in this view. The cameras orientation can be adjusted via arrow buttons (← → ↑ ↓). A full screen mode is also available.

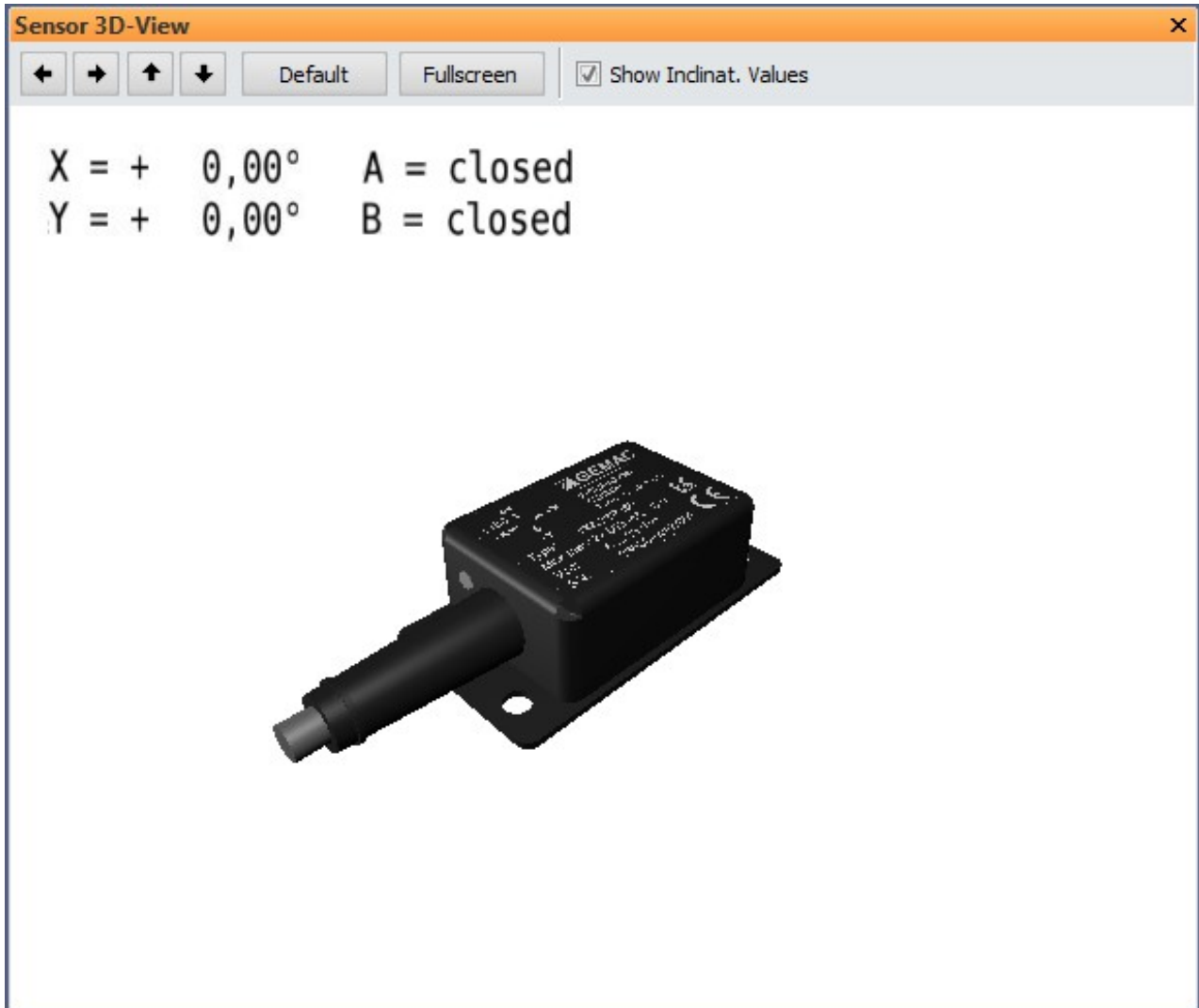

Figure 25: Sensor 3D-view

⁶ View of the current switch status is available for inclination switches with firmware version v1.05 or higher.

7.2.7 View „Sensor Oscilloscope“

You can display the angles values of a connected inclination switch ISW2SP360 as a function of time in the view “Sensor Oscilloscope”. The angle values are displayed with a frequency of 4 Hz (internal sampling rate of the inclination switch is higher).

You can adjust time base, amplitude and offset as you know from an oscilloscope. There is a logging function to export angle values to a CSV file.

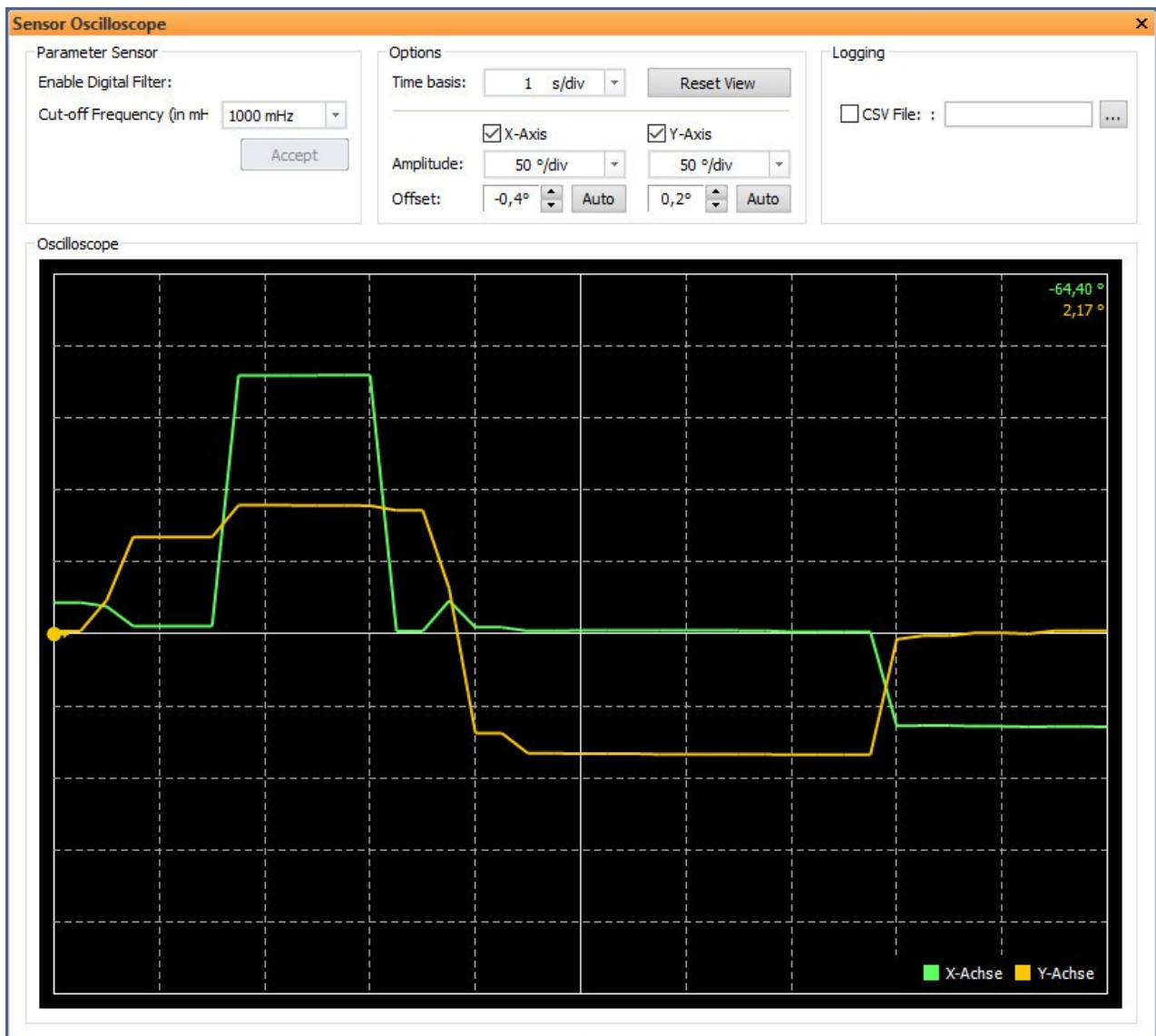

Figure 26: Oscilloscope view of angle values

8 Maintenance and Service

8.1 Calibration

Every inclination switch ISW2SP360 is calibrated by factory before delivery. Measured values can vary from accuracies given in this document without this calibration.

Therefore calibration should be repeated once a year. This can only be carried out by the manufacturer.

8.2 Service

8.2.1 Return

Return of the inclination switch ISW2SP360 or the programming device ISWPA1 for calibration or repairing purposes must occur in original packaging or an equivalent packaging. Please give a short error description and provide a telephone number for further questions.

8.2.2 Support

Please specify serial number and firmware version number of your inclination switch ISW2SP360 and your programming device ISWPA1 when technical issues occur.

Manufacturer: GEMAC - Gesellschaft für Mikroelektronikanwendung Chemnitz mbH

Zwickauer Str. 227

09116 Chemnitz

Germany

Tel. +49 371 3377 – 0

Fax +49 371 3377 – 272

Web <http://www.gemac-chemnitz.de>

E-Mail info@gemac-chemnitz.de

8.2.3 Warranty and restriction of liability

There is a warranty period of 24 months for the inclination switch ISW2SP360 and the programming device ISWPA1. The warranty shall begin with the date of delivery. Within the period of warranty incidental repairs, which are covered by the warranty, are free. Damage due to improper use or operation outside of specification given by this document may not be covered by the warranty.

GEMAC - Gesellschaft für Mikroelektronikanwendung Chemnitz mbH shall be liable for consequential damages from the use of the product only in case of intent or gross negligence.

The general terms and conditions of business of GEMAC - Gesellschaft für Mikroelektronikanwendung Chemnitz mbH apply and are available on our website.

9 Ordering information

Order number	Product Type	Description
PR-23666-00	ISW2SP360	Inclination switch
PR-23997-00	ISWPA1	Inclination switch programming device

Table 15: Ordering information